

C55

YALITIMLISIZ KAPI-PENCERE SİSTEMİ UNINSULATED WINDOW&DOOR SYSTEM

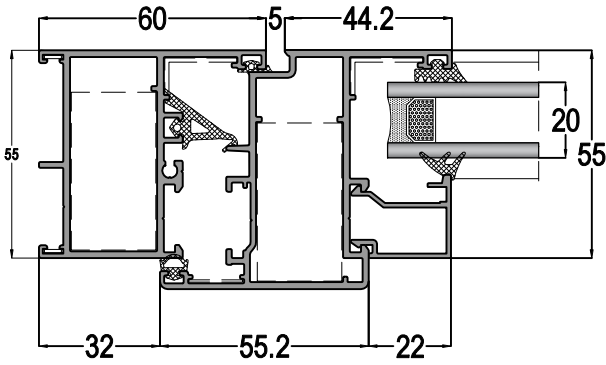

- İç bini, dış bini ve orta tozluk fitili sayesinde maksimum hava ve su performansı / Inner gasket, outer gasket and gasket for open joint maximum air and water performance
- Diğer sistemler ile ortak cam çitası kullanımı / Use of common glazing bead compatible with other systems
- Kolay montaj / Easy installation
- Düz kanat tasarımı ile görsel sunum zenginliği / Visual presentation with flat sash design

KASA GENİŞLİĞİ : 55 mm

Frame width

SİSTEM ET KALINLIĞI : 1,4mm-1,8mm-2mm

System wall tickness

CAM KALINLIĞI : 4-40 mm

Glass thickness



AKSESUAR SEÇİMİ : Euro norm kanallı profiller , PVC aksesuarına uygun profiller (multi point lock) /

Sash width : Profiles with euronorm channels, Profiles suitable for PVC accesory

AÇILIM TİPLERİ : Tek kanat pencere, Çift kanat pencere, Vasistas açılım, Pivot açılım, İçeri açılır tek kanat kapı, İçeri açılır çift kanat kapı, Dışa açılır tek kanat Pencere, Dışa açılır tek kanat kapı, Dışarı açılır çift kanat kapı, Katlanır kapı, Paralel sürme

Opening types : Single-sash window, double-sash window, transom window, pivot window, inward-opening single sash door, inward-opening double-sash door, outward-opening single-sash door&window, outward-opening double-sash door, folding door, parallel sliding

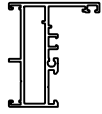
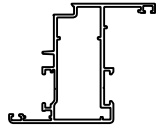
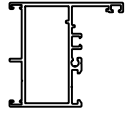
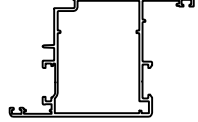
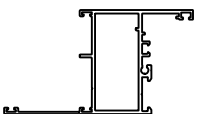
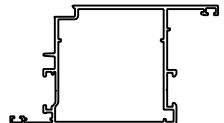
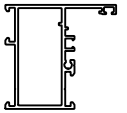
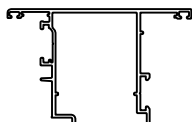
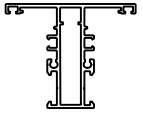
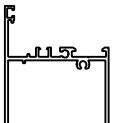
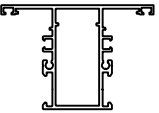

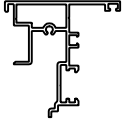
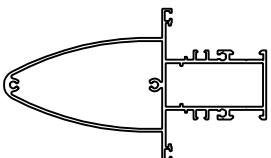
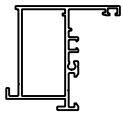
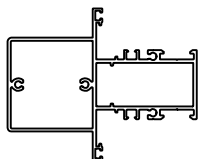
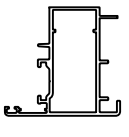
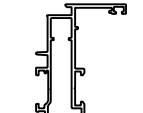
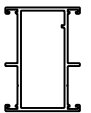





PROFİL LİSTESİ - PROFILES LIST

C55 01	Jx cm ⁴	Jy cm ⁴		C55 12	Jx cm ⁴	Jy cm ⁴	
	13,93	4,42			26,02	9,94	
KASA PROFİLİ-48 mm FRAME PROFILE	AĞIRLIK / Weight			KANAT PROFİLİ-44 mm SASH PROFILE	AĞIRLIK / Weight		
	1,023 kg/mt				1,282 kg/mt		
C55 02	Jx cm ⁴	Jy cm ⁴		C55 13	Jx cm ⁴	Jy cm ⁴	
	17,03	9,74			44,50	21,57	
KASA PROFİLİ-60 mm FRAME PROFILE	AĞIRLIK / Weight			İÇE AÇILIR KAPI KANAT PROFİLİ 64mm INWARD OPENING DOOR SASH PROFILE	AĞIRLIK / Weight		
	1,140 kg/mt				1,478 kg/mt		
C55 03	Jx cm ⁴	Jy cm ⁴		C55 15	Jx cm ⁴	Jy cm ⁴	
	21,36	20,88			59,11	29,03	
PERVAZLI KASA PROFİLİ FRAME PROFILE	AĞIRLIK / Weight			İÇE AÇILIR KAPI KANAT PROFİLİ 77 mm INWARD OPENING DOOR SASH PROFILE	AĞIRLIK / Weight		
	1,286 kg/mt				1,602 kg/mt		
C55 04	Jx cm ⁴	Jy cm ⁴		C55 14	Jx cm ⁴	Jy cm ⁴	
	18,01	8,53			31,11	33,14	
KASA PROFİLİ FRAME PROFILE	AĞIRLIK / Weight			DIŞA AÇILIR KAPI KANAT PROFİLİ OUTWARD OPENING DOOR SASH PROFILE	AĞIRLIK / Weight		
	1,139 kg/mt				1,473 kg/mt		
C55 21	Jx cm ⁴	Jy cm ⁴		C55 31	Jx cm ⁴	Jy cm ⁴	
	16,26	8,28			104,06	36,64	
ORTA KAYIT PROFİLİ 69 mm TRANSOM-MULLION PROFILE	AĞIRLIK / Weight			ETEK PROFİLİ-130 mm BOTTOM PLATE PROFILE	AĞIRLIK / Weight		
	1,225 kg/mt				1,948 kg/mt		
C55 22	Jx cm ⁴	Jy cm ⁴		12-35			
	19,44	15,87					
ORTA KAYIT PROFİLİ 80 mm TRANSOM-MULLION PROFILE	AĞIRLIK / Weight			EŞİK PROFİLİ BOTTOM RAIL PROFILE	AĞIRLIK / Weight		
	1,342 kg/mt				0,523 kg/mt		
C55 23	Jx cm ⁴	Jy cm ⁴		C55 41			
	32,36	88,07					
ORTA KAYIT PROFİLİ 130 mm TRANSOM-MULLION PROFILE	AĞIRLIK / Weight			ÇİFT KANAT ADAPTÖR PROFİLİ DOUBLE SASH ADAPTER PROFILE	AĞIRLIK / Weight		
	1,824 kg/mt				1,041 kg/mt		
C55 24	Jx cm ⁴	Jy cm ⁴		C55 43			
	132,88	25,86					
TAKVİYELİ ORTA KAYIT PROFİLİ SUPPORTED MULLION PROFILE	AĞIRLIK / Weight			DIŞA AÇILIR KAPI ADAPTÖR PROFİLİ OUTWARD OPENING DOOR ADAPTER PROFILE	AĞIRLIK / Weight		
	2,263 kg/mt				1,085 kg/mt		
C55 25	Jx cm ⁴	Jy cm ⁴		C55 50			
	70,54	25,44					
TAKVİYELİ ORTA KAYIT PROFİLİ SUPPORTED MULLION PROFILE	AĞIRLIK / Weight			PİVOT AÇILIM ADAPTÖR PROFİLİ PIVOTING ADAPTER PROFILE	AĞIRLIK / Weight		
	2,061 kg/mt				1,148 kg/mt		
C55 11	Jx cm ⁴	Jy cm ⁴		C55 44			
	21,45	7,07					
KANAT PROFİLİ-30 mm SASH PROFILE	AĞIRLIK / Weight			ÇARPMA KAPI ADAPTÖR PROFİLİ ADAPTER PROFILE	AĞIRLIK / Weight		
	1,150 kg/mt				0,938 kg/mt		

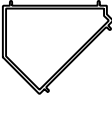
* Sipariş öncesi kalıp bilgisi kontrol edilmeli / must be check profile mold before the order

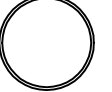
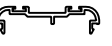
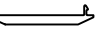

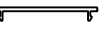

Profil ağırlıklarımız teorik olup; teslim anındaki tartımız geçerlidir.

PROFİL LİSTESİ - PROFILES LIST



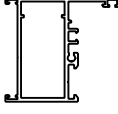
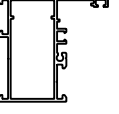
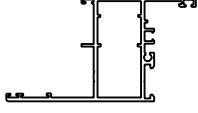
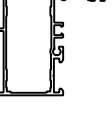
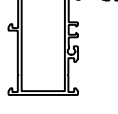
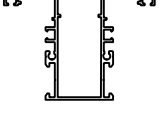
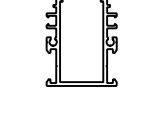
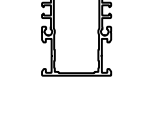
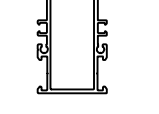
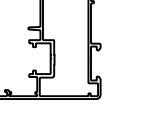
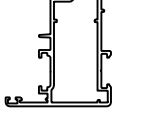

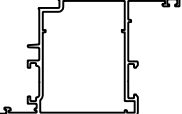
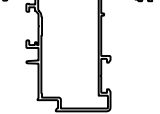
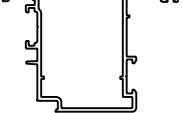
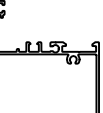
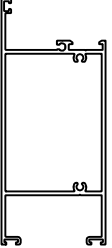















C55 51	Jx cm*	Jy cm*		12-41	
	10,80	14,75			
90° KÖŞE PROFİLİ CORNER PROFILE	AĞIRLIK / Weight			TİJ PROFİLİ SASH PROFILE	AĞIRLIK / Weight
	0,843 kg/mt				
C55 52	Jx cm*	Jy cm*			
	3,40	8,07			
135° KÖŞE PROFİLİ CORNER PROFILE	AĞIRLIK / Weight				
	0,758 kg/mt				
C55 54	AĞIRLIK / Weight				
	0,441 kg/mt				
C55 55	AĞIRLIK / Weight				
	0,567 kg/mt				
01-000500-15	AĞIRLIK / Weight				
	0,619 kg/mt				
C55 45	AĞIRLIK / Weight				
	0,448 kg/mt				
C55 46	AĞIRLIK / Weight				
	0,691 kg/mt				
C55 47	AĞIRLIK / Weight				
	0,184 kg/mt				
C55 48	AĞIRLIK / Weight				
	0,335 kg/mt				
C55 49	AĞIRLIK / Weight				
	0,179 kg/mt				

PROFİL LİSTESİ / 2 mm - PROFILES LIST / 2mm







PROFİL LİSTESİ / 1.4 mm - PROFILES LIST / 1.4mm

C55 202	Jx cm ⁴	Jy cm ⁴		C55 104	Jx cm ⁴	Jy cm ⁴	
	21,38	9,19			15,05	7,28	
2mm KASA PROFİLİ 2mm FRAME PROFILE	AĞIRLIK / Weight			1.4mm KASA PROFİLİ 1.4mm FRAME PROFILE	AĞIRLIK / Weight		
	1,215 kg/mt				0,965 kg/mt		
C55 203				C55 105	Jx cm ⁴	Jy cm ⁴	
					16,50	7,90	
2mm KASA PROFİLİ 2mm FRAME PROFILE	AĞIRLIK / Weight			1.4mm KASA PROFİLİ 1.4mm FRAME PROFILE	AĞIRLIK / Weight		
	1,502 kg/mt				1,016 kg/mt		
C55 204	Jx cm ⁴	Jy cm ⁴		C55 122	Jx cm ⁴	Jy cm ⁴	
	19,69	8,95			16,28	13,84	
2mm KASA PROFİLİ 2mm FRAME PROFILE	AĞIRLIK / Weight			1.4mm ORTA KAYIT PROFİLİ - 81 mm TRANSOM-MULLION PROFILE	AĞIRLIK / Weight		
	1,214 kg/mt				1,136 kg/mt		
C55 222	Jx cm ⁴	Jy cm ⁴		C55 123	Jx cm ⁴	Jy cm ⁴	
	21,01	16,97			17,83	15,09	
2mm ORTA KAYIT PROFİLİ - 81 mm TRANSOM-MULLION PROFILE	AĞIRLIK / Weight			1.4mm ORTA KAYIT PROFİLİ - 81 mm TRANSOM-MULLION PROFILE	AĞIRLIK / Weight		
	1,448 kg/mt				1,213 kg/mt		
C55 223	Jx cm ⁴	Jy cm ⁴		C55 114	Jx cm ⁴	Jy cm ⁴	
	20,95	17,41			27,28	8,63	
2mm ORTA KAYIT PROFİLİ - 81 mm TRANSOM-MULLION PROFILE	AĞIRLIK / Weight			1.4 mm KANAT PROFİLİ MULTI POINT SİSTEM SASH PROFILE-MULTI POINT	AĞIRLIK / Weight		
	1,434 kg/mt				1,181 kg/mt		
C55 212	Jx cm ⁴	Jy cm ⁴		C55 115	Jx cm ⁴	Jy cm ⁴	
	34,00	10,59			51,94	23,91	
2mm KANAT PROFİLİ 2mm SASH PROFILE	AĞIRLIK / Weight			1.4mm İÇE AÇILIR KAPI KANAT PROFİLİ 1.4mm INNER OPENING DOOR SASH PROFILE	AĞIRLIK / Weight		
	1,445 kg/mt				1,351 kg/mt		
C55 213	Jx cm ⁴	Jy cm ⁴		C55 117	Jx cm ⁴	Jy cm ⁴	
	49,91	24,03			23,13	17,38	
2mm İÇE AÇILIR KAPI KANAT PROFİLİ 2mm INWARD OPENING DOOR SASH PROFILE	AĞIRLIK / Weight			1.4mm DIŞA AÇILIR PENCERE KANAT PRO. OUTWARD OPENING WINDOW SASH PROFILE	AĞIRLIK / Weight		
	1,664 kg/mt				1,169 kg/mt		
C55 214	Jx cm ⁴	Jy cm ⁴		C55 131	Jx cm ⁴	Jy cm ⁴	
	38,68	33,88			109,58	39,47	
2mm DIŞA AÇILIR KAPI KANAT PROFİLİ 2mm OUTWARD OPENING DOOR SASH PROFILE	AĞIRLIK / Weight			1.4mm ETEK PROFİLİ 1.4mm BOTTOM PLATE PROFILE	AĞIRLIK / Weight		
	1,670 kg/mt				1,636 kg/mt		
C55 231	Jx cm ⁴	Jy cm ⁴					
	109,58	39,47					
2mm ETEK PROFİLİ 2mm BOTTOM PLATE PROFILE	AĞIRLIK / Weight						
	2,083 kg/mt						

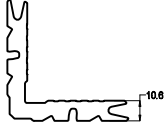
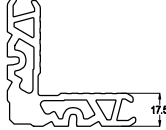
PROFİL LİSTESİ - PROFILES LIST

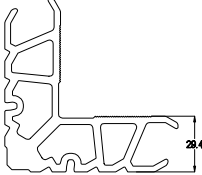
11-004			11-032		
CAM ÇİTASI-4 mm GLAZING BEAD PROFILE	AĞIRLIK / Weight 0,181 kg/mt		CAM ÇİTASI-32 mm GLAZING BEAD PROFILE	AĞIRLIK / Weight 0,315 kg/mt	
11-006			11-035		
CAM ÇİTASI-6 mm GLAZING BEAD PROFILE	AĞIRLIK / Weight 0,218 kg/mt		CAM ÇİTASI-35 mm GLAZING BEAD PROFILE	AĞIRLIK / Weight 0,323 kg/mt	
11-010			11-038		
CAM ÇİTASI-10 mm GLAZING BEAD PROFILE	AĞIRLIK / Weight 0,233 kg/mt		CAM ÇİTASI-38 mm GLAZING BEAD PROFILE	AĞIRLIK / Weight 0,334 kg/mt	
11-015			12-01		
CAM ÇİTASI-15 mm GLAZING BEAD PROFILE	AĞIRLIK / Weight 0,242 kg/mt		DAMLALIK PROFİLİ RAINDROP PROFILE	AĞIRLIK / Weight 0,198 kg/mt	
11-017			12-02		
CAM ÇİTASI-17 mm GLAZING BEAD PROFILE	AĞIRLIK / Weight 0,250 kg/mt		DAMLALIK PROFİLİ RAINDROP PROFILE	AĞIRLIK / Weight 0,136 kg/mt	
11-020			12-03		
CAM ÇİTASI-20 mm GLAZING BEAD PROFILE	AĞIRLIK / Weight 0,276 kg/mt		DAMLALIK PROFİLİ RAINDROP PROFILE	AĞIRLIK / Weight 0,313 kg/mt	
11-022			12-52		
CAM ÇİTASI-22 mm GLAZING BEAD PROFILE	AĞIRLIK / Weight 0,282 kg/mt		PERVAZ PROFİLİ BORDER PROFILE	AĞIRLIK / Weight 0,279 kg/mt	
11-026			12-53		
CAM ÇİTASI-26 mm GLAZING BEAD PROFILE	AĞIRLIK / Weight 0,296 kg/mt		PERVAZ MONTAJ PROFİLİ BORDER FIXING PROFILE	AĞIRLIK / Weight 0,177 kg/mt	
11-028			12-54		
CAM ÇİTASI-28 mm GLAZING BEAD PROFILE	AĞIRLIK / Weight 0,302 kg/mt		PERVAZ PROFİLİ BORDER PROFILE	AĞIRLIK / Weight 0,326 kg/mt	
11-030			12-57		
CAM ÇİTASI-30 mm GLAZING BEAD PROFILE	AĞIRLIK / Weight 0,308 kg/mt		PERVAZ PROFİLİ BORDER PROFILE	AĞIRLIK / Weight 0,358 kg/mt	

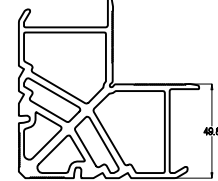
PROFİL LİSTESİ - PROFILES LIST

04-025025-12		T		
KASA T'Sİ - 30 mm FRAME BORDER	AĞIRLIK / Weight 0,159 kg/mt			
10-010106-00				
KÖŞE TAKOZU-10,6 mm CORNER JOINT	AĞIRLIK / Weight 2,653 kg/mt			
10-010175-00				
KÖŞE TAKOZU-17,5 mm CORNER JOINT	AĞIRLIK / Weight 3,336 kg/mt			
10-010225-00				
KÖŞE TAKOZU-22,5 mm CORNER JOINT	AĞIRLIK / Weight 3,566 kg/mt			
10-010294-00				
KÖŞE TAKOZU-22,5 mm CORNER JOINT	AĞIRLIK / Weight 4,825 kg/mt			
10-010429-00				
KÖŞE TAKOZU-42,7 mm CORNER JOINT	AĞIRLIK / Weight 5,483 kg/mt			
10-010553-00				
KÖŞE TAKOZU-55,3 mm CORNER JOINT	AĞIRLIK / Weight 6,251 kg/mt			
12-91				
DİK BAĞLANTI T JOINT	AĞIRLIK / Weight 0,794 kg/mt			













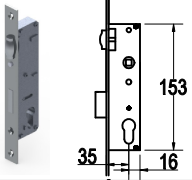
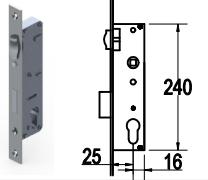

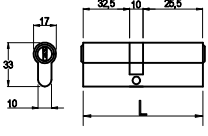
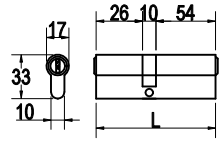
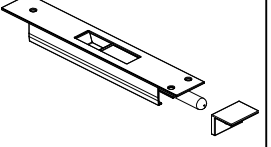
AKSESUAR LİSTESİ - ACCESSORIES LIST

EP1-01			ASI-H 9730		
DIŞ CAM FİTİLİ - 2,5 mm OUTER GLAZING GASKET	KOLİ MİKTARI/Package 240 mt / 15 kg		SİSTEM İKİLİ MENTEŞE DOUBLE SYSTEM HINGE	KOLİ MİKTARI/Package 250 Adet / Piece	
KC 02			ASI-H 9733		
CAM FİTİLİ - 2 mm GLAZING GASKET	KOLİ MİKTARI/Package 100 mt / 4,5 kg		SİSTEM ÜÇLÜ MENTEŞE TRIPLE SYSTEM HINGE	KOLİ MİKTARI/Package 250 Adet / Piece	
EP2-01			ASI-H 3300		
İÇ CAM FİTİLİ - 3 mm INNER GLAZING GASKET	KOLİ MİKTARI/Package 440 mt / 15 kg		SİSTEM KAPI MENTEŞESİ SYSTEM DOOR HINGE	KOLİ MİKTARI/Package Adet / Piece	
EP2-02			ASI-V 820		
İÇ CAM FİTİLİ - 4 mm INNER GLAZING GASKET	KOLİ MİKTARI/Package 300 mt / 15 kg		VASİSTAS AÇILIM KOLU TRANSOM OPENING HANDLE	KOLİ MİKTARI/Package 30 Adet / Piece	
EP4-06			ASI-V 816		
ORTA BİNİ FİTİLİ GASKET FOR OPEN JOINT	KOLİ MİKTARI/Package 130 mt / 15 kg		VASİSTAS AÇILIM KOLU TRANSOM OPENING HANDLE	KOLİ MİKTARI/Package 50 Adet / Piece	
EP4-06K			ASI-V 1000		
VULKANİZE FİTİL GASKET FOR CORNER	KOLİ MİKTARI/Package Adet / Piece		VASİSTAS MAKAS (PVC) TRANSOM RESTRICTOR	KOLİ MİKTARI/Package 120 Adet / Piece	
EP3-03			ASI-V 1080		
KANAT BİNİ FİTİLİ SASH GASKET	KOLİ MİKTARI/Package 430 mt / 15 kg		VASİSTAS MAKAS TRANSOM RESTRICTOR	KOLİ MİKTARI/Package 60 Adet / Piece	
EP3-02			ASI-V 1275-3		
KASA BİNİ FİTİLİ FRAME GASKET	KOLİ MİKTARI/Package 750 mt / 15 kg		VASİSTAS 3 KADEMELİ ÇELİK MAKAS TRANSOM RESTRICTOR WITH 3 POSITIONS	KOLİ MİKTARI/Package 2'li Takım/ Set	
KF 67-600			ASI-V 1275-5		
FİRÇA FİTİL - 6mm BRUSH GASKET	KOLİ MİKTARI/Package 1300 mt		VASİSTAS 5 KADEMELİ ÇELİK MAKAS TRANSOM RESTRICTOR WITH 5 POSITIONS	KOLİ MİKTARI/Package 2'li Takım/ Set	
KF 67-1000			ASI-V 0148		
FİRÇA FİTİL - 10mm BRUSH GASKET	KOLİ MİKTARI/Package 600 mt		VASİSTAS ÇELİK MAKAS TRANSOM STEEL RESTRICTOR	KOLİ MİKTARI/Package 2'li Takım/ Set	





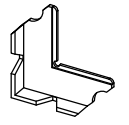

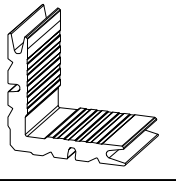
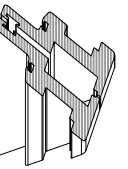
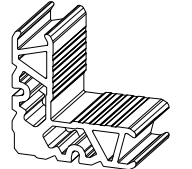

AKSESUAR LİSTESİ - ACCESSORIES LIST

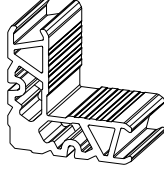
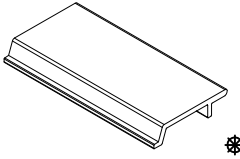
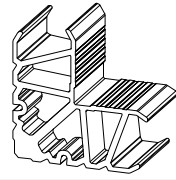
ASI-WH 003			ASI-WH 005		
TEK DİLLİ EKSENEL KOL WINDOW HANDLE	KOLİ MİKTARI/Package Adet / Piece		DIŞA AÇILIR PENCERE KANAT KOLU WINDOW HANDLE FOR OUTWARD OPENING	KOLİ MİKTARI/Package Adet / Piece	
ASI-WH 004			ASI-WH005-58		
ÇİFT DİLLİ EKSENEL KOL WINDOW HANDLE	KOLİ MİKTARI/Package Adet / Piece		DIŞA AÇILIR PENCERE KOL DİLLİ - 58mm HANDLE FORK FOR OUTWARD OPENING - 58mm	KOLİ MİKTARI/Package Adet / Piece	
ASI-WH 004A			ASI-WH 005K		
ÇİFT DİLLİ EKSENEL KOL - ANAHTARLI WINDOW HANDLE WITH LOCK	KOLİ MİKTARI/Package Adet / Piece		DIŞA AÇILIR PENCERE KOL BAĞLANTI-19mm HANDLE CONNECTOR FOR OUTWARD OPENING-19mm	KOLİ MİKTARI/Package Adet / Piece	
ASI-KA M108			ASI-RP 001		
EKSENEL KOL KİLİTLEME MEKANİZMASI LOCKING FOR WINDOW	KOLİ MİKTARI/Package Adet / Piece		TİJ PİMİ ROD PROFILE LOCKING	KOLİ MİKTARI/Package Adet / Piece	
ASI-KA P200			ASI-RS 001		
EKSENEL KOL KİLİTLEME MEKANİZMASI LOCKING FOR WINDOW	KOLİ MİKTARI/Package Adet / Piece		PİM KARŞILIĞI ROD PROFILE STRIKES	KOLİ MİKTARI/Package 120 Adet / Piece	
ASI-KA VNT			ASI-WH 007		
KANAT SABİTLEME SASH FIXING	KOLİ MİKTARI/Package Adet / Piece		DIŞA AÇILIR KARE MİLLİ PENCERE KOLU BAS WINDOW HANDLE FOR OUTWARD OPENING	KOLİ MİKTARI/Package Adet / Piece	
ASI-WH 001			ASI-RP 002		
KARE MİLLİ PENCERE KOLU WINDOW HANDLE	KOLİ MİKTARI/Package Adet / Piece		DIŞA AÇILIM TİJ PİMİ ROD PROFILE LOCKING FOR OUTWARD OPENING	KOLİ MİKTARI/Package Adet / Piece	
ASI-WH 001A			ASI-RS 003		
KARE MİLLİ PENCERE KOLU-ANAHTARLI WINDOW HANDLE WITH LOCK	KOLİ MİKTARI/Package Adet / Piece		DIŞA AÇILIM PİM KARŞILIĞI ROD PROFILE STRIKES FOR OUTWARD OPENING	KOLİ MİKTARI/Package	
ASI-WH 001B			ASI-GB 001		
KARE MİLLİ PENCERE KOLU - İKİLİ TAKIM WINDOW HANDLE WITH LOCK	KOLİ MİKTARI/Package Takım / Set		DIŞA AÇILIM KOL MEKANİZMASI LOCKING FOR WINDOW FOR OUTWARD OPENING	KOLİ MİKTARI/Package Adet / Piece	
ASI-DH 002			ASI-153 35		
KAPI KOLU DOOR HANDLE	KOLİ MİKTARI/Package Adet / Piece		DİLLİ KİLİT MOURTISE LOCK WITH CYLINDER	KOLİ MİKTARI/Package Adet / Piece	

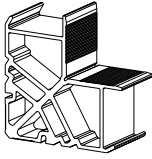
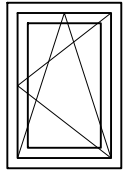
AKSESUAR LİSTESİ - ACCESSORIES LIST

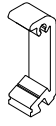
ASI-LS 90185D			ASI-YKM 001		
DİLLİ KİLİT KARŞILIĞI LOCK STRIKES	KOLİ MİKTARI/Package Adet / Piece		ÇARPMA KAPI MENTEŞE SWING DOOR HINGE	KOLİ MİKTARI/Package Adet / Piece	
ASI-155 35			ASI-155U25		
MAKARALI KİLİT MOURTİSE LOCK WITH ROLLER	KOLİ MİKTARI/Package Adet / Piece		ÇARPMA KAPI MAKARALI KİLİT SWING DOOR MOURTİSE LOCK WITH ROLLER	KOLİ MİKTARI/Package Adet / Piece	
ASI-LS 90185M			ASI-BRL 68		
MAKARALI KİLİT KARŞILIĞI ROLLER LOCK STRIKES	KOLİ MİKTARI/Package Adet / Piece		ÇARPMA KAPI 68 LİK BAREL SWING DOOR CYLINDER 68	KOLİ MİKTARI/Package Adet / Piece	
ASI-BRL 90			AK 545		
90 LİK BAREL CYLINDER 90	KOLİ MİKTARI/Package Adet / Piece		ÇARPMA KAPI SÜRGÜ SWING DOOR BOLT	KOLİ MİKTARI/Package Adet	
ASI-225			C55 HOK		
BAREL AYNASI (Beyaz,Siyah,Gri) DOOR HANDLE CYLINDER (White,Black,Grey)	KOLİ MİKTARI/Package Adet / Piece		ADAPTÖR KAPAĞI ADAPTER COVER	KOLİ MİKTARI/Package alt-üst 1 takım	
ASI-B 2217			ASI-SB 19		
SÜRGÜ KİLİTLEME-KISA SASH FIXING LOCK-SHORT	KOLİ MİKTARI/Package 240 Adet / Piece		KÖŞE GÖNYESİ CORNER ALIGNMENT	KOLİ MİKTARI/Package 1000 Adet / Piece	
ASI-B 2215			ASI-SB 19.1		
SÜRGÜ KİLİTLEME-UZUN SASH FIXING LOCK-LONG	KOLİ MİKTARI/Package 120 Adet / Piece		KÖŞE GÖNYESİ CORNER ALIGNMENT	KOLİ MİKTARI/Package 1000 Adet / Piece	
ASI-DH 60Y			ASI-MO 21		
ÇEKME KAPI KOLU DOOR HANDLE	KOLİ MİKTARI/Package Adet / Piece		PLASTİK KÖŞE GÖNYESİ CORNER ALIGNMENT	KOLİ MİKTARI/Package Adet / Piece	
ASI-DH 40KB			ASI-KT 1142		
ÇEKME KAPI KOLU DOOR HANDLE	KOLİ MİKTARI/Package Adet / Piece		KÖŞE TAKOZU CORNER JOINT	KOLİ MİKTARI/Package Adet / Piece	
ASI-PVM 002			ASI-KT 2342		
PİVOT MENTEŞE PIVOTING HINGE	KOLİ MİKTARI/Package Adet / Piece		KÖŞE TAKOZU CORNER JOINT	KOLİ MİKTARI/Package Adet / Piece	

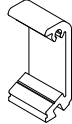
AKSESUAR LİSTESİ - ACCESSORIES LIST

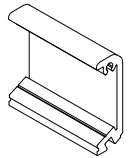
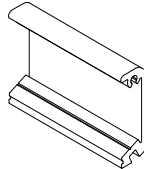
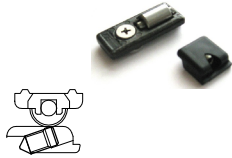
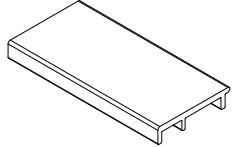
ASI-KT 1455			SG50-55-02		
KÖŞE TAKOZU CORNER JOINT	KOLİ MİKTARI/Package Adet / Piece		KASA CAM TAKOZU GLASS SUPPORT FOR FRAME	KOLİ MİKTARI/Package Adet / Piece	
ASI-KT 4342			ASI-F 100A		
KÖŞE TAKOZU CORNER JOINT	KOLİ MİKTARI/Package Adet / Piece		KAPI ALTI FIRÇASI DOOR BRUSH GASKET	KOLİ MİKTARI/Package Adet / Piece	
ASI-KT 5542			ASI-ALU TT		
KÖŞE TAKOZU CORNER JOINT	KOLİ MİKTARI/Package Adet / Piece		ÇİFT EKSEN AÇILIM MEKANİZMASI TILT&TURN OPENING	KOLİ MİKTARI/Package Adet / Piece	
ASI-P 100.1			ASI-LTT K01		
ORTA KAYIT BAĞLANTI T JOINT FIXING	KOLİ MİKTARI/Package 250 Adet / Piece		ÇİFT KANAT AÇILIM PASİF KANAT LEVYE KOLU INACTIVE SASH HIDDEN HANDLE	KOLİ MİKTARI/Package Takım / Set	
ASI-DB 9111			ASI-MEK VW		
DİK BAĞLANTI T JOINT	KOLİ MİKTARI/Package Adet / Piece		PARALEL SÜRME MEKANİZMASI TILT&SLIDE OPENING	KOLİ MİKTARI/Package Takım / Set	
ASI-DB 9123			ASI-WDC 01		
DİK BAĞLANTI T JOINT	KOLİ MİKTARI/Package Adet / Piece		YAĞMUR TAHLİYE KAPAĞI WATER REJECT COVER	KOLİ MİKTARI/Package Adet / Piece	
ASI-DB 9164					
DİK BAĞLANTI T JOINT	KOLİ MİKTARI/Package Adet / Piece				
ASI-DB 9172					
DİK BAĞLANTI T JOINT	KOLİ MİKTARI/Package Adet / Piece				
ASI-SS 01					
KANAT DESTEK TAKOZU SASH SUPPORT BOTTOM	KOLİ MİKTARI/Package Takım / Set				
SG50-55-01					
KANAT CAM TAKOZU GLASS SUPPORT FOR SASH	KOLİ MİKTARI/Package Adet / Piece				

C55 - 1,8mm

YALITIMSIZ KAPI-PENCERE SİSTEMİ
COLD WINDOW&DOOR SYSTEM

ASISTAL



PROFİL DETAYLARI
PROFILE DETAILS

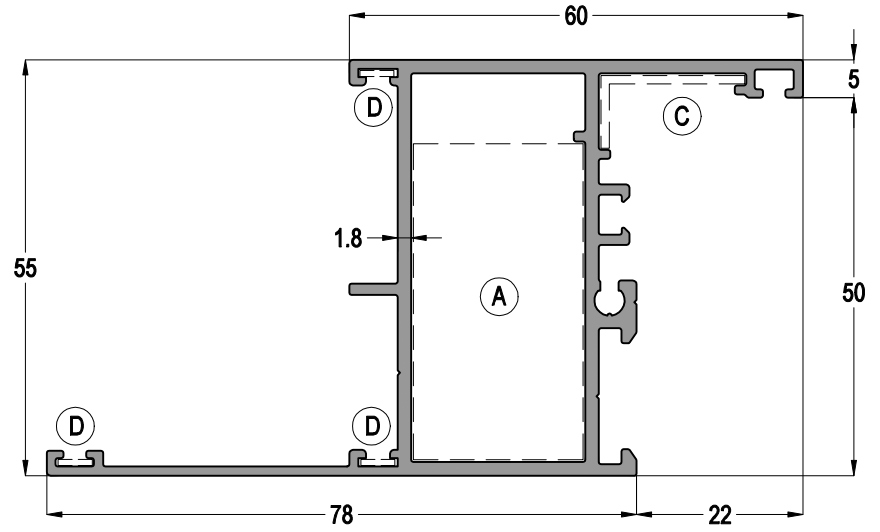
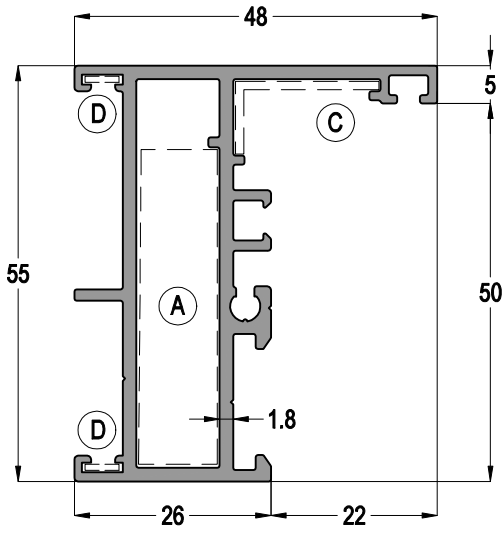

C55 - 1,8mm

YALITIMSIZ KAPI-PENCERE SİSTEMİ
COLD WINDOW&DOOR SYSTEM

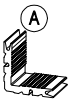
ASISTAL

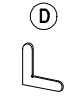

C55 01			Jx cm ⁴	Jy cm ⁴
			13,93	4,42
 ASI-KT 1142	 ASI-MO 21	 ASI-SB 19	AĞIRLIK / Weight	
			1,023 kg/mt	

C55 03			Jx cm ⁴	Jy cm ⁴
			21,36	20,88
 ASI-KT 2342	 ASI-MO 21	 ASI-SB 19	AĞIRLIK / Weight	
			1,286 kg/mt	

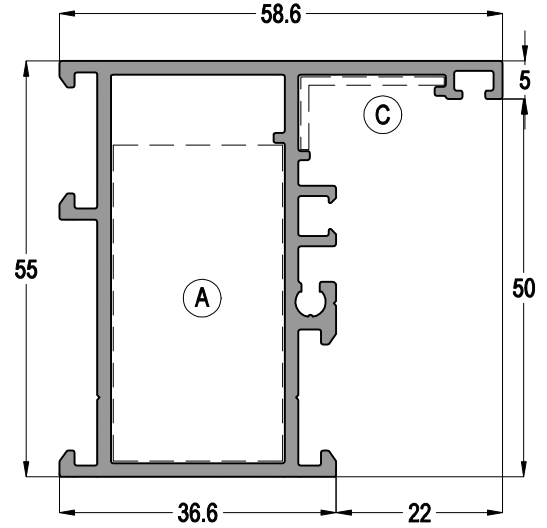
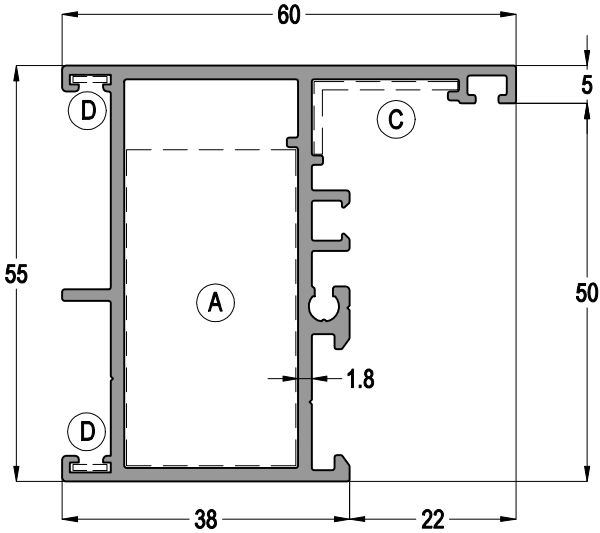

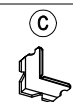
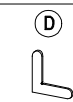
C55 02			Jx cm ⁴	Jy cm ⁴
			17,03	9,74
 ASI-KT 2342	 ASI-MO 21	 ASI-SB 19	AĞIRLIK / Weight	
			1,140 kg/mt	

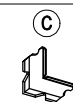
C55 04			Jx cm ⁴	Jy cm ⁴
			18,01	8,53
 ASI-KT 2342	 ASI-MO 21		AĞIRLIK / Weight	
			1,139 kg/mt	



Profil ağırlıklarımız teorik olup; teslim anındaki tartımız geçerlidir.
Profile weights are theoretical and the weight at the time of delivery is valid.

C55 - 1,8mm

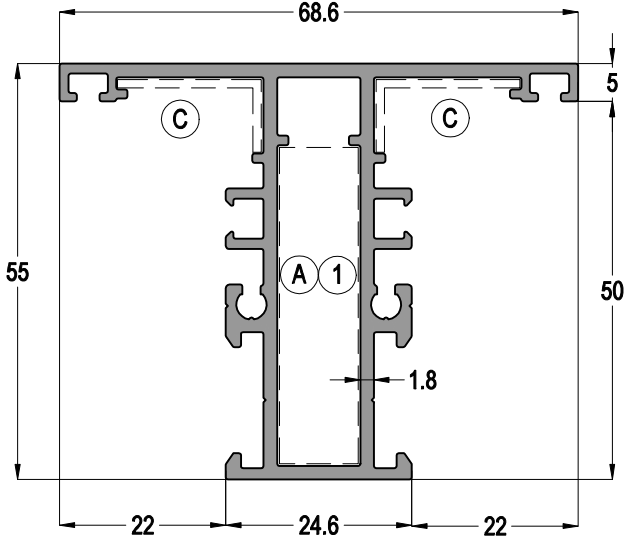

YALITIMSIZ KAPI-PENCERE SİSTEMİ
COLD WINDOW&DOOR SYSTEM

ASISTAL

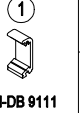

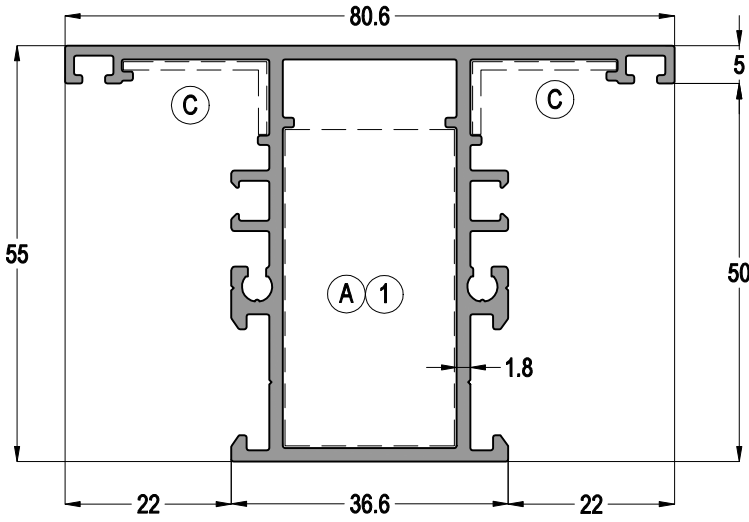
C55 21			Jx cm ⁴	Jy cm ⁴
			16,26	8,28
 ASI-KT 1142	 ASI-MO 21	 ASI-DB 9111	AĞIRLIK / Weight	
			1,225 kg/mt	

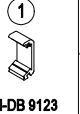

C55 22			Jx cm ⁴	Jy cm ⁴
			19,44	15,87
 ASI-KT 2342	 ASI-MO 21	 ASI-DB 9123	AĞIRLIK / Weight	
			1,342 kg/mt	

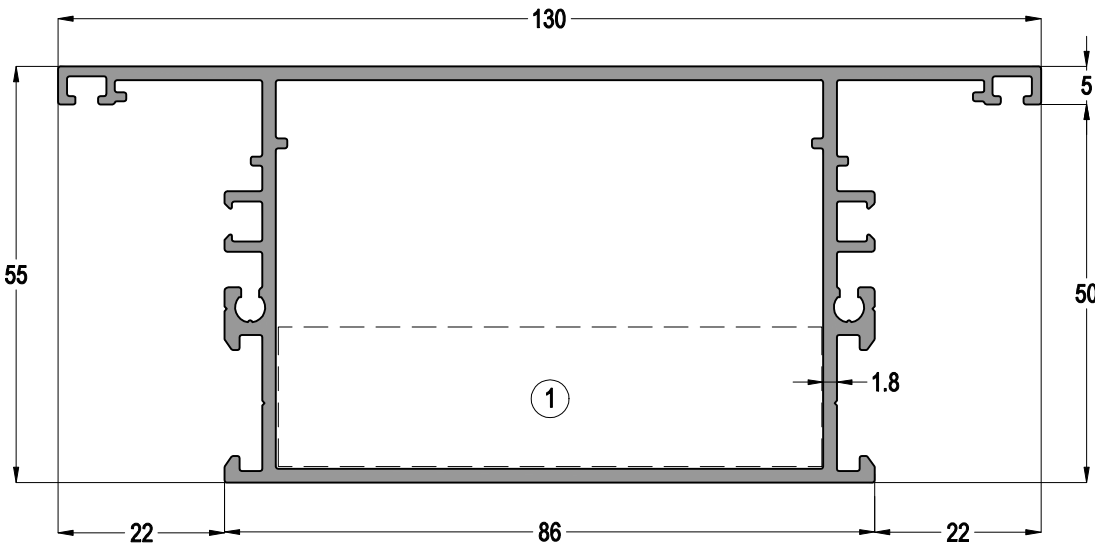



C55 23			Jx cm ⁴	Jy cm ⁴
			32,36	88,07
			AĞIRLIK / Weight	
			1,824 kg/mt	

Profil ağırlıklarımız teorik olup; teslim anındaki tartımız geçerlidir.
Profile weights are theoretical and the weight at the time of delivery is valid.

C55 - 1,8mm

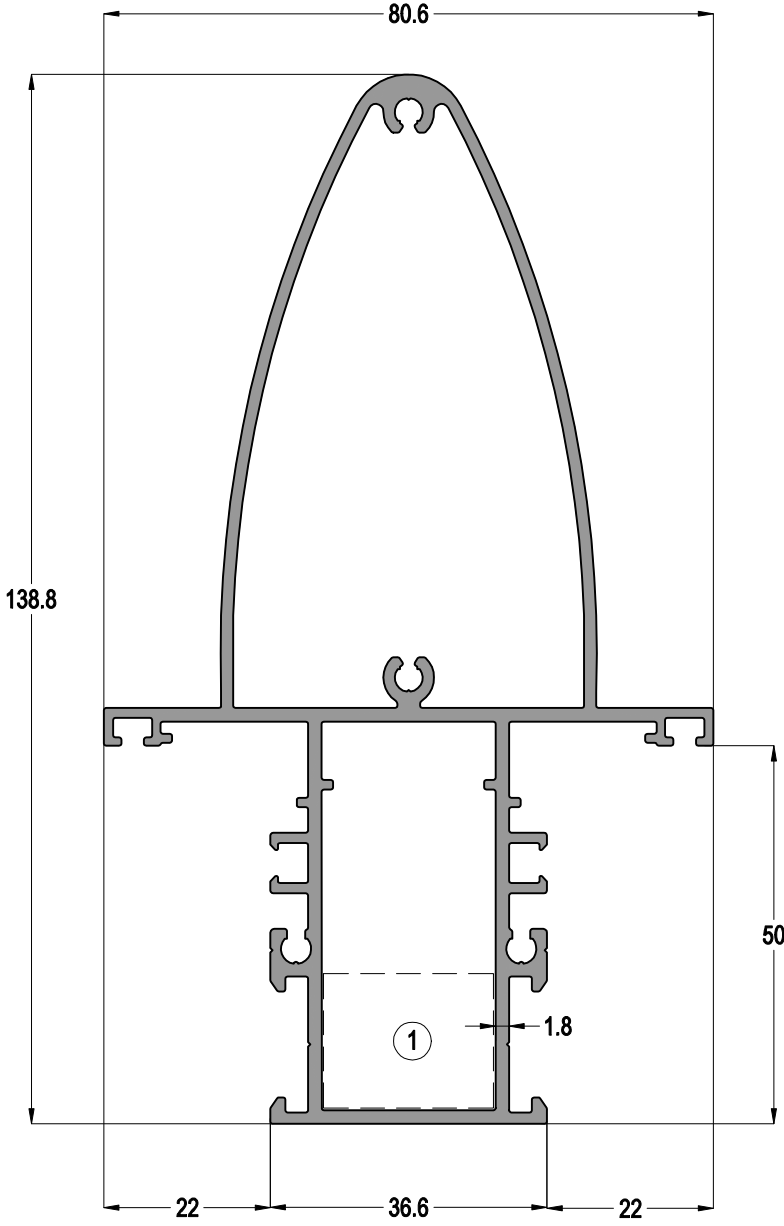
YALITIMSIZ KAPI-PENCERE SİSTEMİ
COLD WINDOW&DOOR SYSTEM



C55 24	Jx cm ⁴	Jy cm ⁴
	132,88	25,86
 ASI-DB 9123	AĞIRLIK / Weight	
	2,263 kg/mt	

C55 25	Jx cm ⁴	Jy cm ⁴
	70,54	25,44
 ASI-DB 9123	AĞIRLIK / Weight	
	2,061 kg/mt	

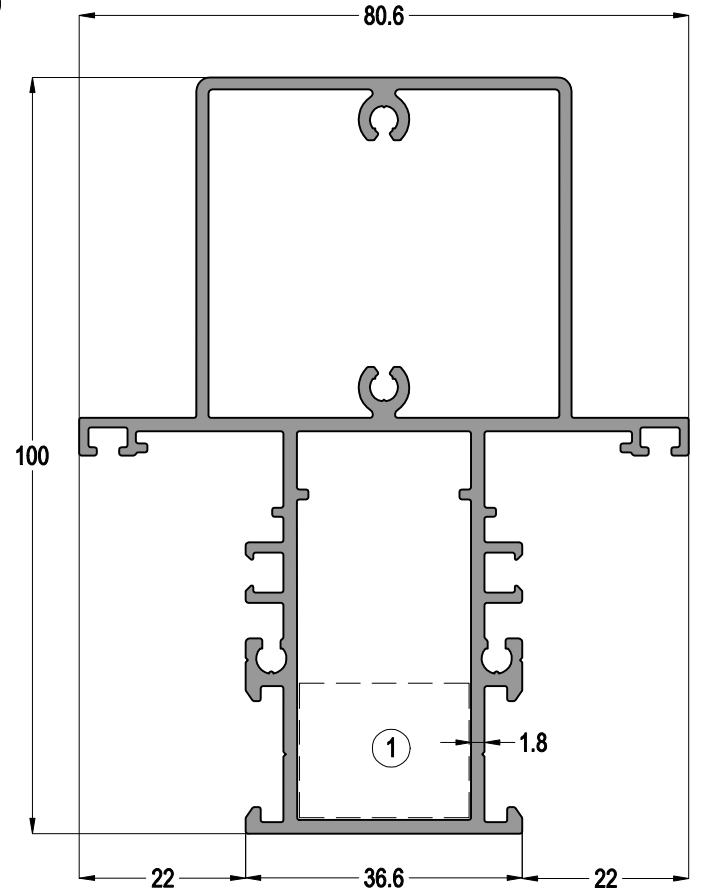





Profil ağırlıklarımız teorik olup; teslim anındaki tartımız geçerlidir.
Profile weights are theoretical and the weight at the time of delivery is valid.

C55 - 1,8mm

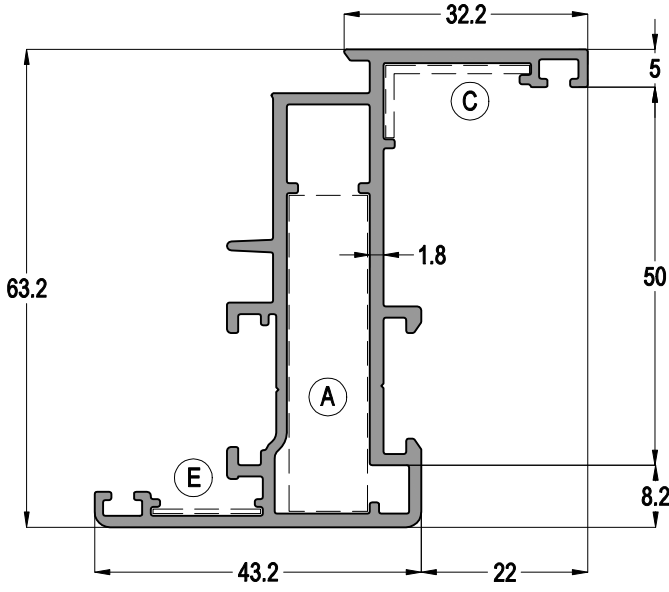

YALITIMSIZ KAPI-PENCERE SİSTEMİ
COLD WINDOW&DOOR SYSTEM

ASISTAL



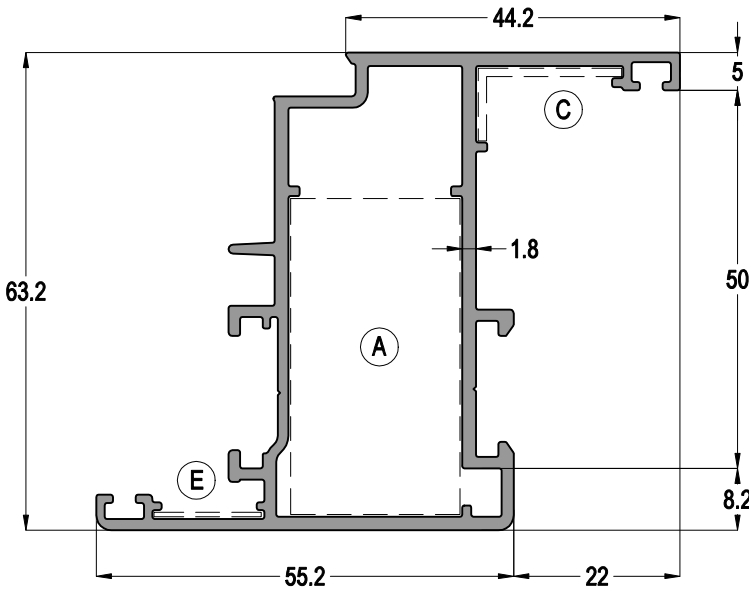

C55 11			Jx cm ⁴	Jy cm ⁴
			21,45	7,07
 ASI-KT 1142	 ASI-MO 21	 ASI-SB 19.1	AĞIRLIK / Weight	
			1,150 kg/mt	

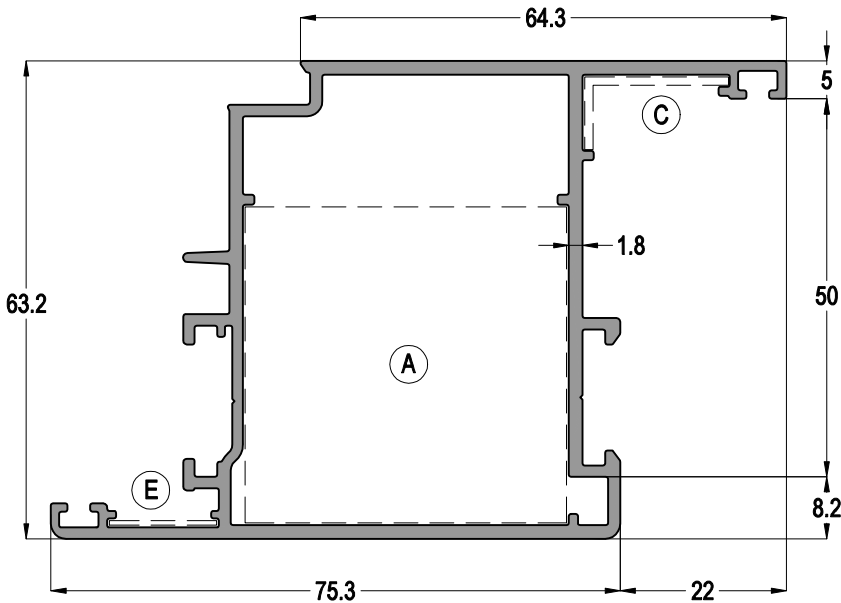

C55 12			Jx cm ⁴	Jy cm ⁴
			26,02	9,94
 ASI-KT 2342	 ASI-MO 21	 ASI-SB 19.1	AĞIRLIK / Weight	
			1,282 kg/mt	



C55 13			Jx cm ⁴	Jy cm ⁴
			44,50	21,57
 ASI-KT 4342	 ASI-MO 21	 ASI-SB 19.1	AĞIRLIK / Weight	
			1,478 kg/mt	



Profil ağırlıklarımız teorik olup; teslim anındaki tartımız geçerlidir.
Profile weights are theoretical and the weight at the time of delivery is valid.

C55 - 1,8mm

YALITIMSIZ KAPI-PENCERE SİSTEMİ
COLD WINDOW&DOOR SYSTEM

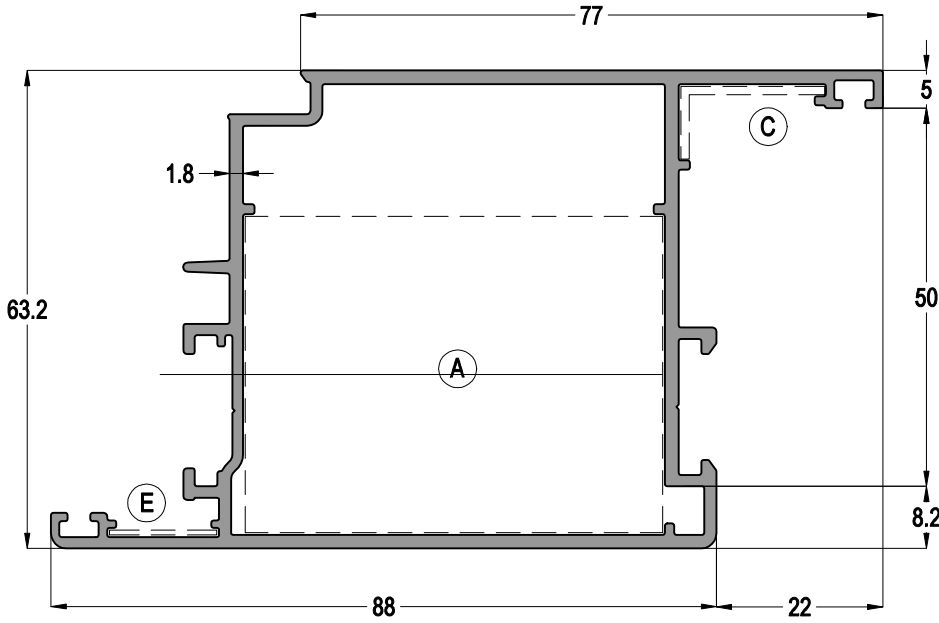
ASISTAL

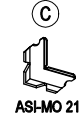

C55 15			Jx cm ⁴	Jy cm ⁴
			59,11	29,03
			AĞIRLIK / Weight	
			1,602 kg/mt	

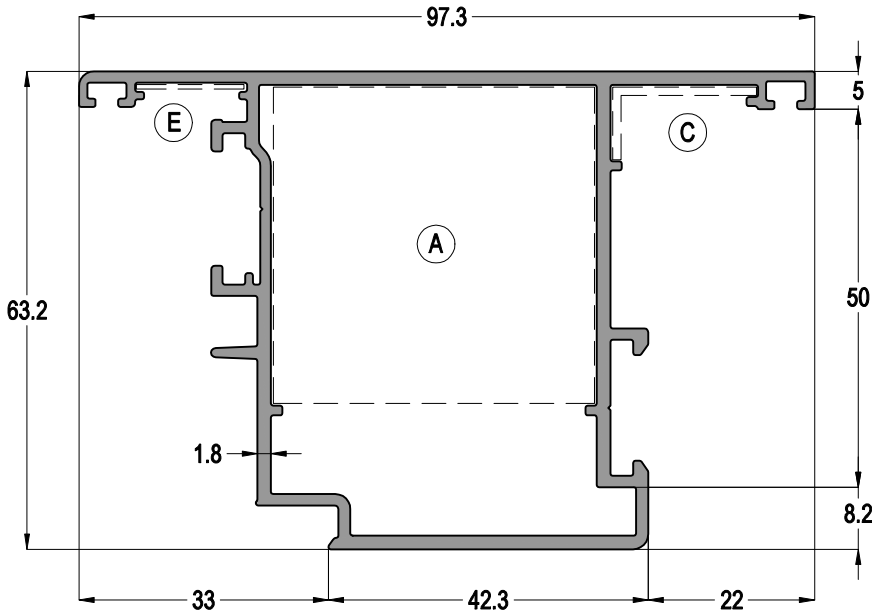

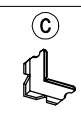
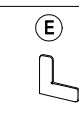
C55 14			Jx cm ⁴	Jy cm ⁴
			31,11	33,14
			AĞIRLIK / Weight	
			1,473 kg/mt	

Profil ağırlıklarımız teorik olup; teslim anındaki tartımız geçerlidir.
Profile weights are theoretical and the weight at the time of delivery is valid.

C55 - 1,8mm

YALITIMSIZ KAPI-PENCERE SİSTEMİ
COLD WINDOW&DOOR SYSTEM



C55 41

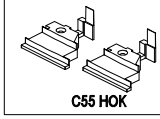

AĞIRLIK / Weight

1,041 kg/mt

C55 43

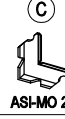

AĞIRLIK / Weight

1,085 kg/mt

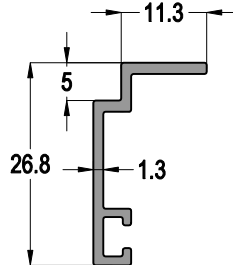
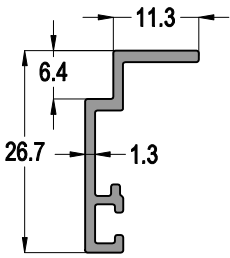
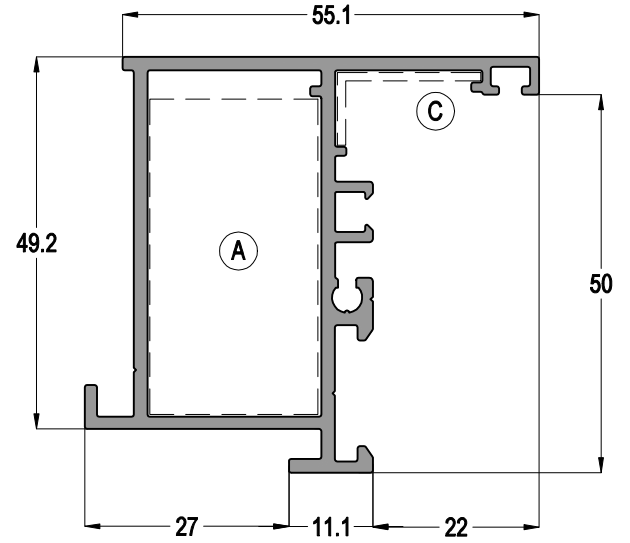
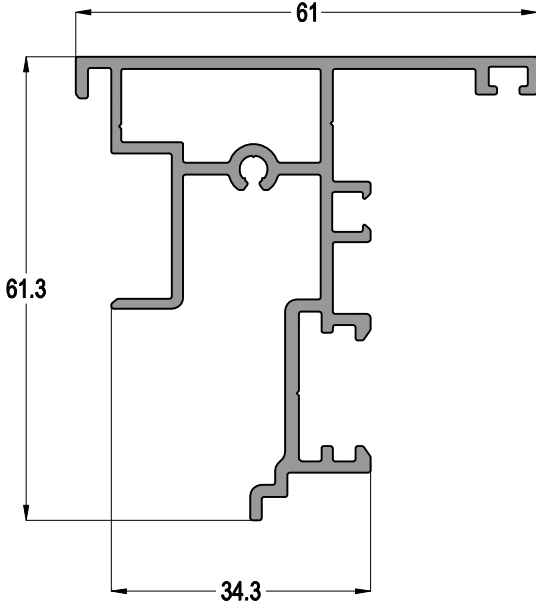

C55 47

0,184 kg/mt

C55 49

0,179 kg/mt

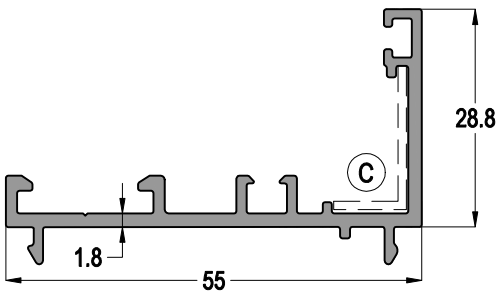
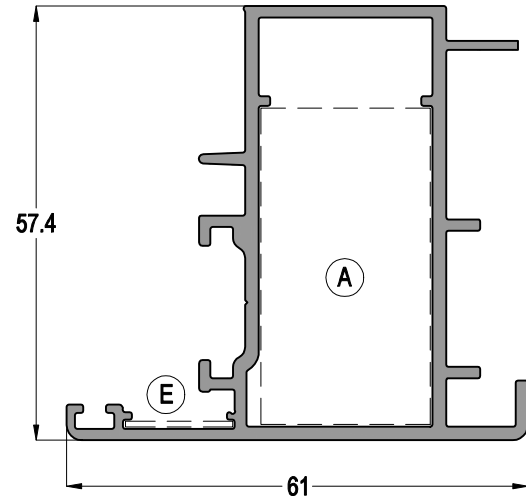

C55 55

0,567 kg/mt

C55 50

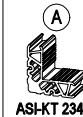

AĞIRLIK / Weight

0,184 kg/mt

Profil ağırlıklarımız teorik olup; teslim anındaki tartımız geçerlidir.
Profile weights are theoretical and the weight at the time of delivery is valid.

C55 - 1,8mm

YALITIMSIZ KAPI-PENCERE SİSTEMİ
COLD WINDOW&DOOR SYSTEM



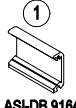

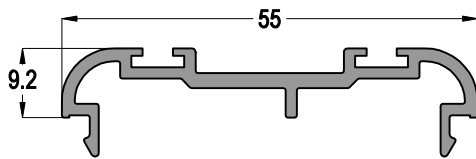
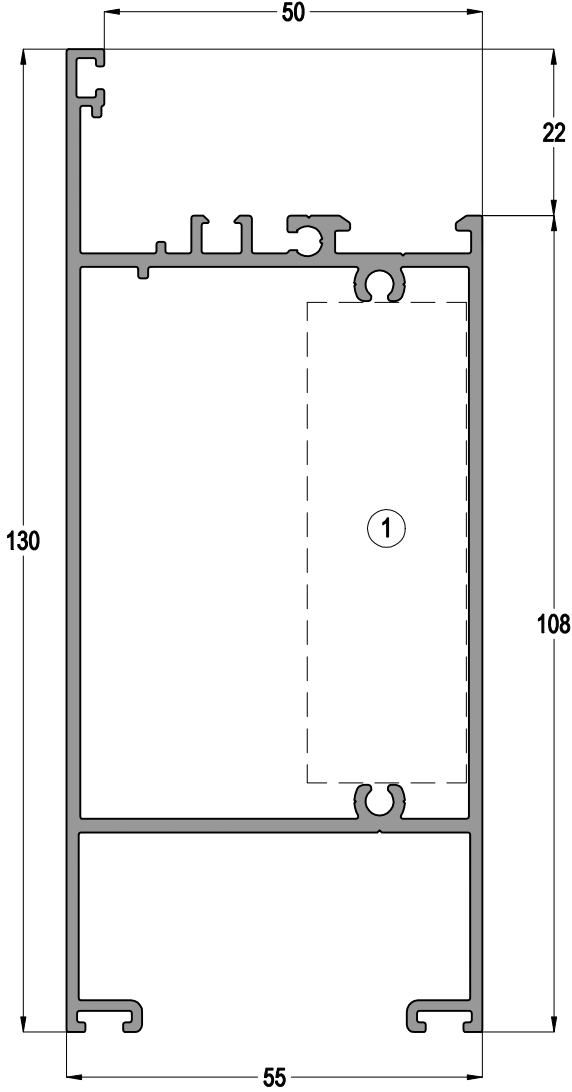
C55 31	Jx cm*	Jy cm*
	104,06	36,64
 ASI-DB 9184	AĞIRLIK / Weight	
	1,948 kg/mt	

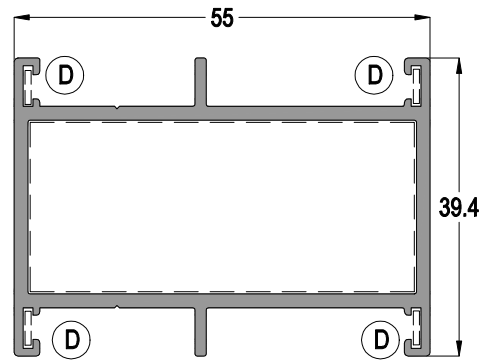
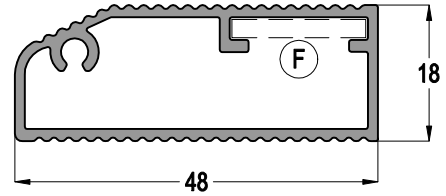

C55 45	
	AĞIRLIK / Weight
	0,448 kg/mt

12-35	
 ASI-P 100.1	AĞIRLIK / Weight
	0,523 kg/mt



C55 44	
 ASI-KT 2351	 ASI-SB 19
AĞIRLIK / Weight	
0,938 kg/mt	



C55 48	
	AĞIRLIK / Weight
	0,335 kg/mt

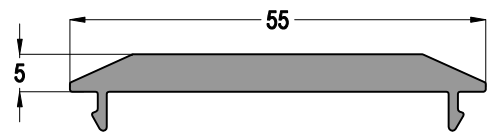

C55 46	
	AĞIRLIK / Weight
	0,691 kg/mt

Profil ağırlıklarımız teorik olup; teslim anındaki tartımız geçerlidir.
Profile weights are theoretical and the weight at the time of delivery is valid.



C55 - 2 mm

YALITIMSIZ KAPI-PENCERE SİSTEMİ
COLD WINDOW&DOOR SYSTEM



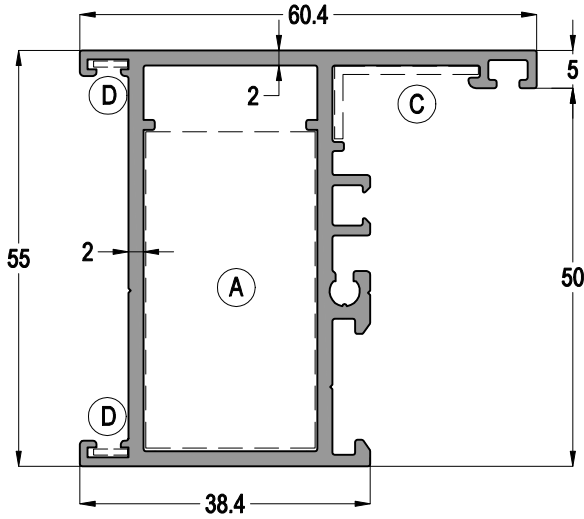

2 mm ET KALINLIĞINDA SİSTEM PROFİLLERİ 2 mm THICKNESS SYSTEM PROFILES

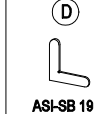

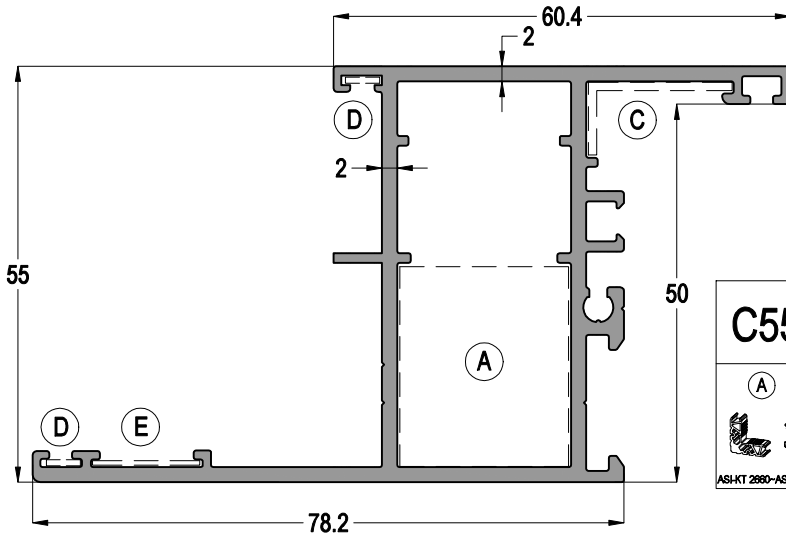
C55 202			Jx cm ⁴	Jy cm ⁴
			21,38	9,19
			AĞIRLIK / Weight	
			1,215 kg/mt	

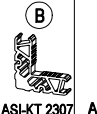
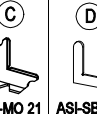
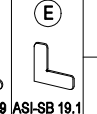

C55 203					AĞIRLIK / Weight
					1,502 kg/mt

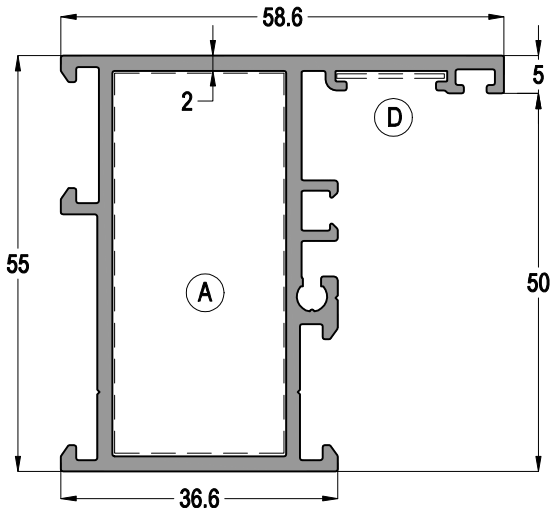

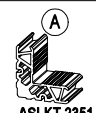
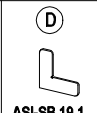
C55 204		Jx cm ⁴	Jy cm ⁴
		19,69	8,95
		AĞIRLIK / Weight	
		1,214 kg/mt	

Profil ağırlıklarımız teorik olup; teslim anındaki tartımız geçerlidir.
Profile weights are theoretical and the weight at the time of delivery is valid.



C55 - 2 mm

YALITIMSIZ KAPI-PENCERE SİSTEMİ
COLD WINDOW&DOOR SYSTEM

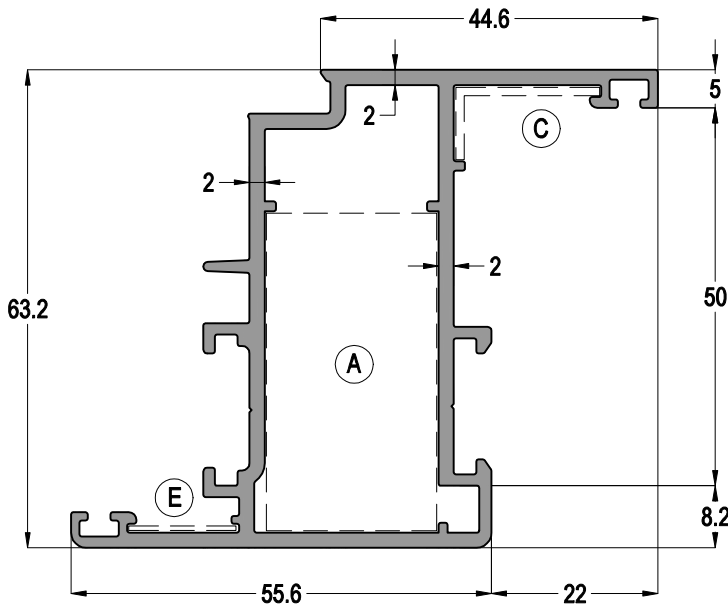
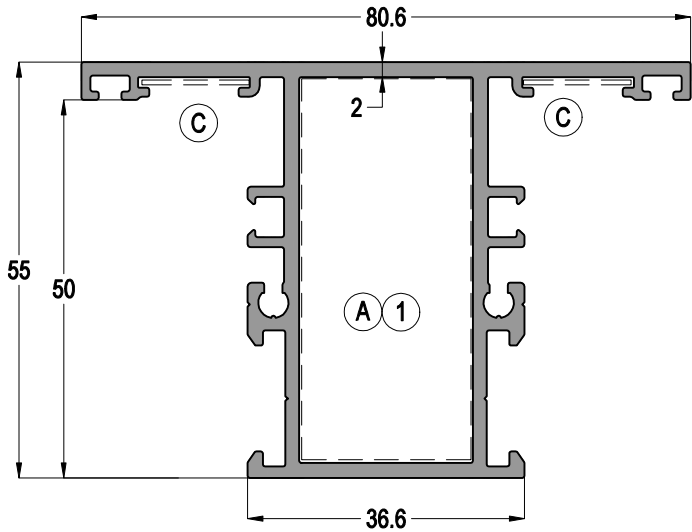
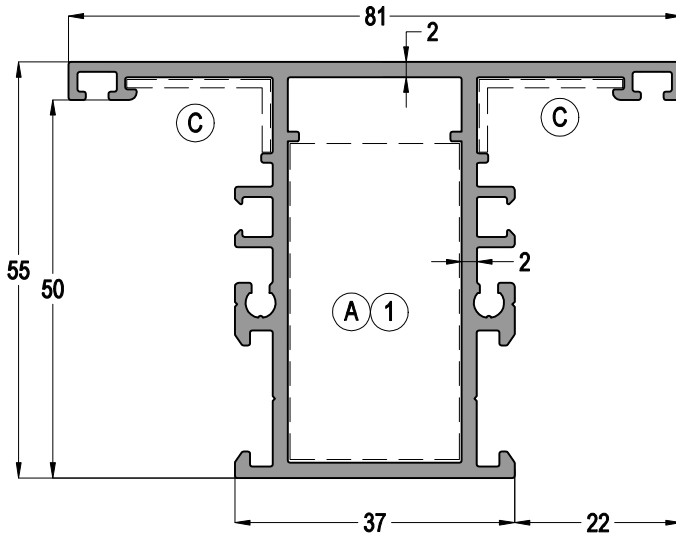

ASISTAL

2 mm ET KALINLIĞINDA SİSTEM PROFİLLERİ 2 mm THICKNESS SYSTEM PROFILES

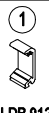

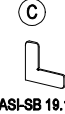
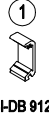
C55 222			Jx cm ⁴	Jy cm ⁴
			21,01	16,97
 ASI-KT 2342	 ASI-MO 21	 ASI-DB 9123	AĞIRLIK / Weight	
			1,448 kg/mt	

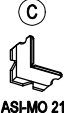
C55 223			Jx cm ⁴	Jy cm ⁴
			20,95	17,41
 ASI-KT 2351	 ASI-SB 19.1	 ASI-DB 9123	AĞIRLIK / Weight	
			1,434 kg/mt	

C55 212			Jx cm ⁴	Jy cm ⁴
			34,00	10,59
 ASI-KT 2342	 ASI-MO 21	 ASI-SB 19.1	AĞIRLIK / Weight	
			1,445 kg/mt	

Profil ağırlıklarımız teorik olup; teslim anındaki tartımız geçerlidir.
Profile weights are theoretical and the weight at the time of delivery is valid.

C55 - 2 mm



YALITIMSIZ KAPI-PENCERE SİSTEMİ
COLD WINDOW&DOOR SYSTEM

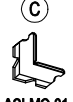
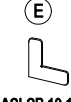

2 mm ET KALINLIĞINDA SİSTEM PROFİLLERİ 2 mm THICKNESS SYSTEM PROFILES

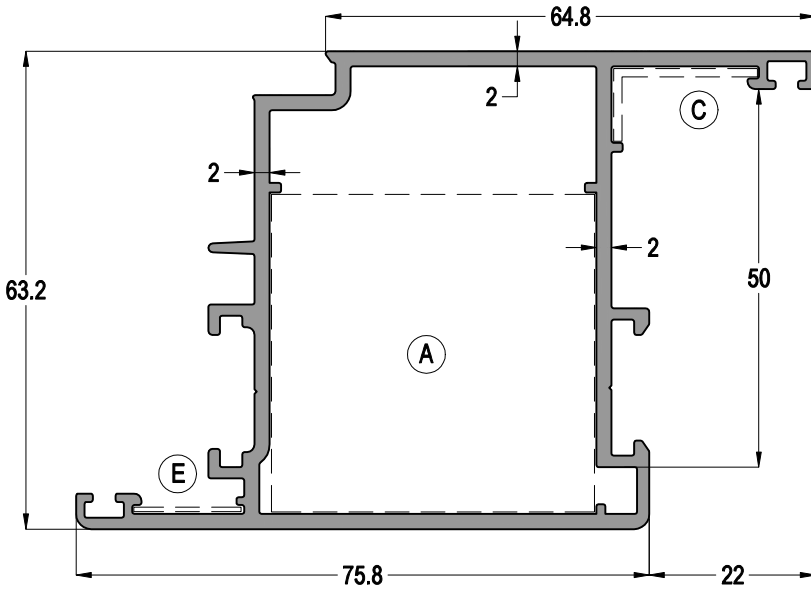
C55 213			Jx cm ⁴	Jy cm ⁴
			49,91	24,03
			AĞIRLIK / Weight	
			1,664 kg/mt	



C55 214			Jx cm ⁴	Jy cm ⁴
			38,68	33,88
			AĞIRLIK / Weight	
			1,670 kg/mt	

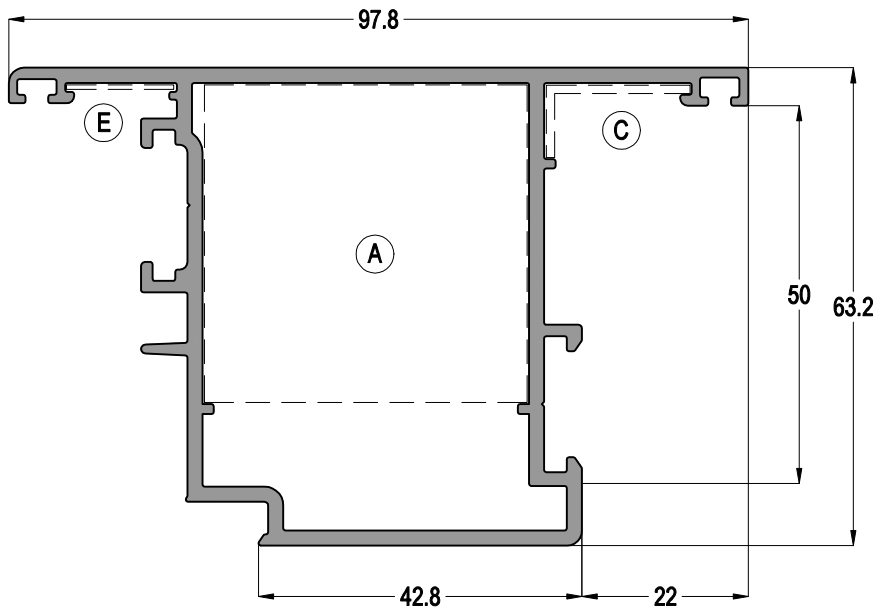

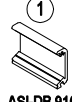
C55 231			Jx cm ⁴	Jy cm ⁴
			109,58	39,47
			AĞIRLIK / Weight	
			2,083 kg/mt	

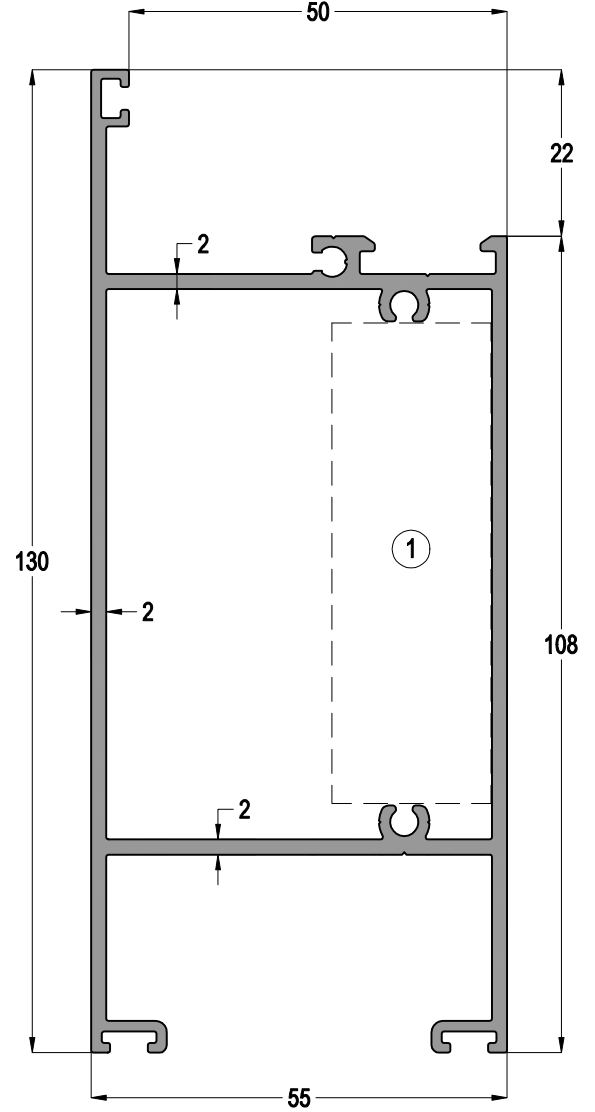

Profil ağırlıklarımız teorik olup; teslim anındaki tartımız geçerlidir.
Profile weights are theoretical and the weight at the time of delivery is valid.



C55 - 1,4mm

YALITIMSIZ KAPI-PENCERE SİSTEMİ
COLD WINDOW&DOOR SYSTEM

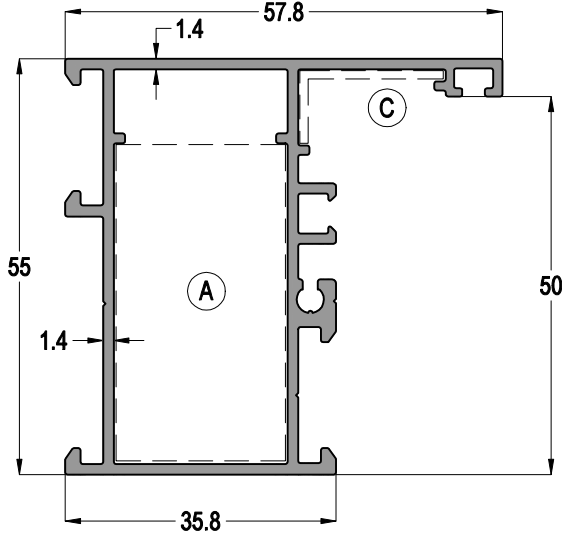

1.4 mm ET KALINLIĞINDA SİSTEM PROFİLLERİ 1.4 mm THICKNESS SYSTEM PROFILES



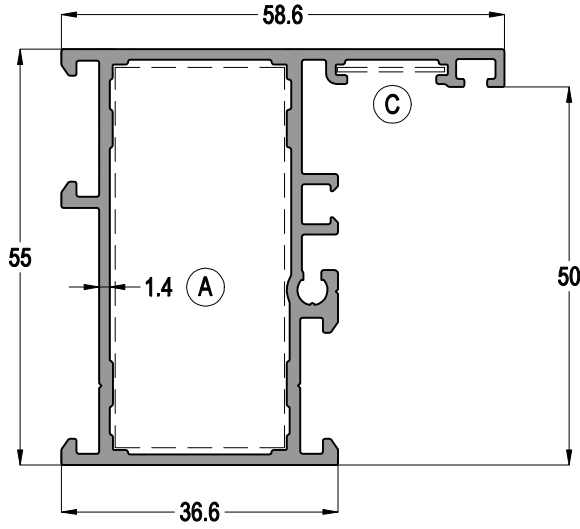

C55 104	Jx cm ⁴	Jy cm ⁴
	15,05	7,28
		AĞIRLIK / Weight
		0,965 kg/mt

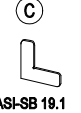

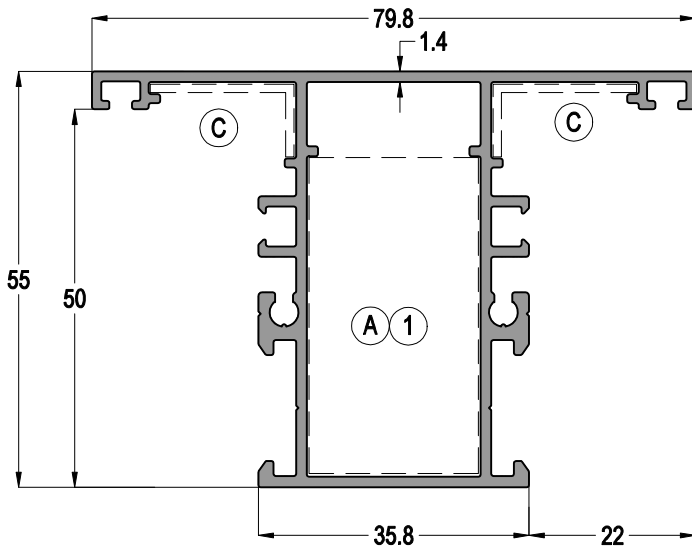
C55 105	Jx cm ⁴	Jy cm ⁴
	16,50	8,95
		AĞIRLIK / Weight
		1,016 kg/mt

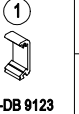

C55 122	Jx cm ⁴	Jy cm ⁴
	16,28	13,84
		
		AĞIRLIK / Weight
		1,136 kg/mt

Profil ağırlıklarımız teorik olup; teslim anındaki tartımız geçerlidir.
Profile weights are theoretical and the weight at the time of delivery is valid.



C55 - 1,4mm

YALITIMSIZ KAPI-PENCERE SİSTEMİ
COLD WINDOW&DOOR SYSTEM

ASISTAL

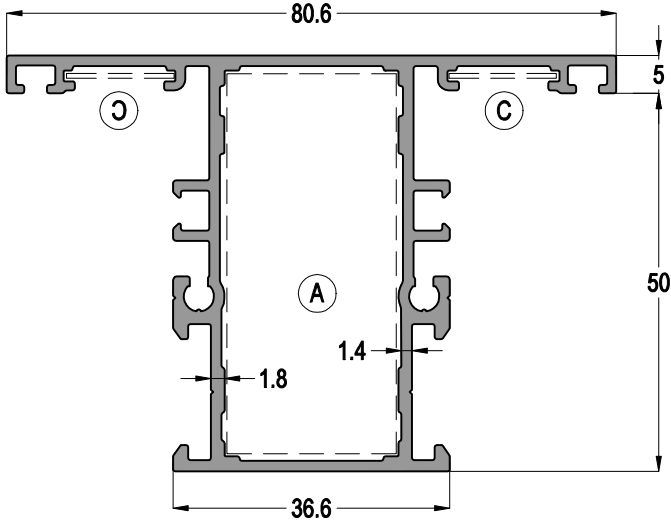
1.4 mm ET KALINLIĞINDA SİSTEM PROFİLLERİ 1.4 mm THICKNESS SYSTEM PROFILES



C55 123			Jx cm ⁴	Jy cm ⁴
			17,83	15,09
 ASI-KT 2351	 ASI-SB 18.1	 ASI-DB 9123	AĞIRLIK / Weight	
			1,213 kg/mt	

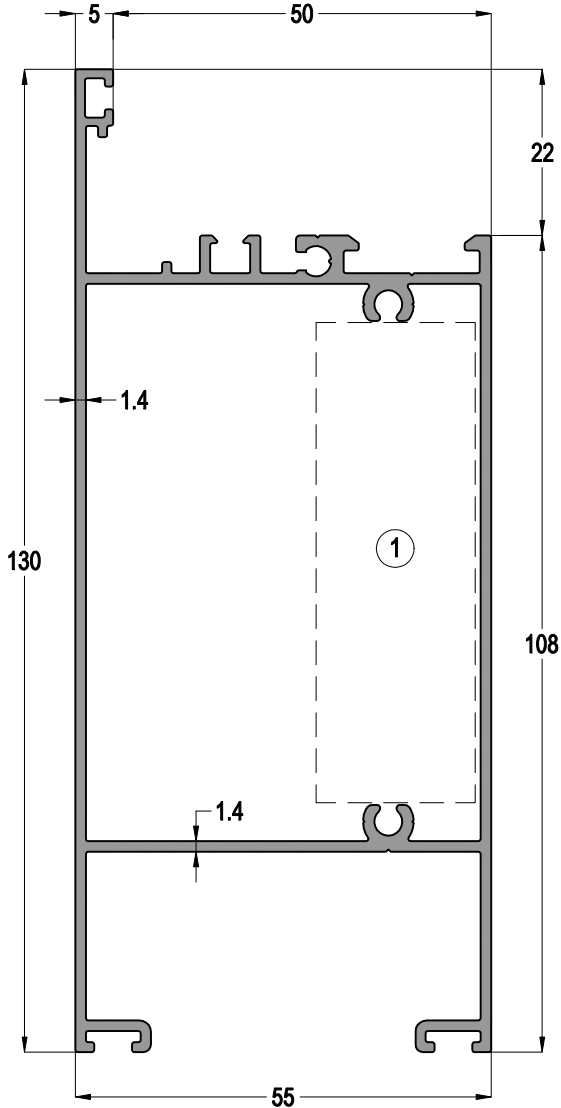

C55 131			Jx cm ⁴	Jy cm ⁴
			109,58	39,47
 ASI-DB 9164			AĞIRLIK / Weight	
			1,636kg/mt	



Profil ağırlıklarımız teorik olup; teslim anındaki tartımız geçerlidir.
Profile weights are theoretical and the weight at the time of delivery is valid.



C55 - 1,4mm

YALITIMSIZ KAPI-PENCERE SİSTEMİ
COLD WINDOW&DOOR SYSTEM





1.4 mm ET KALINLIĞINDA SİSTEM PROFİLLERİ 1.4 mm THICKNESS SYSTEM PROFILES

C55 114			Jx cm ⁴	Jy cm ⁴
			27,28	8,63
			AĞIRLIK / Weight	
ASI-KT 1754	ASI-MO 21	ASI-SB 19.1	1,181 kg/mt	

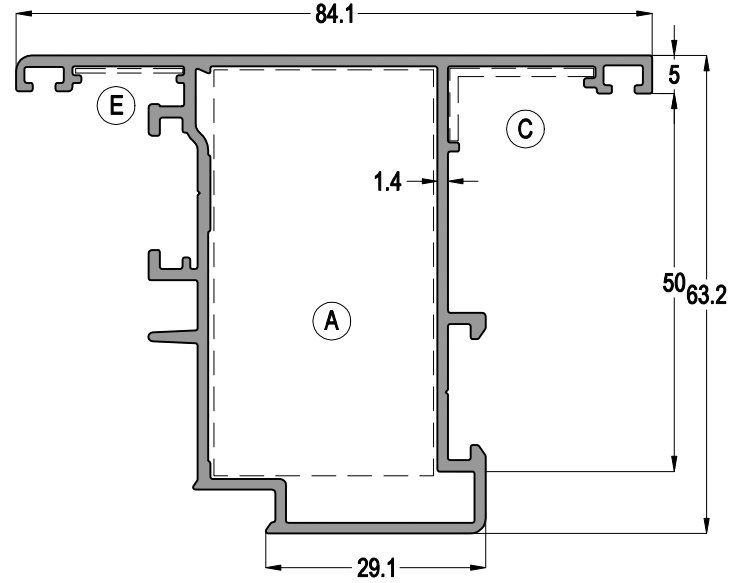
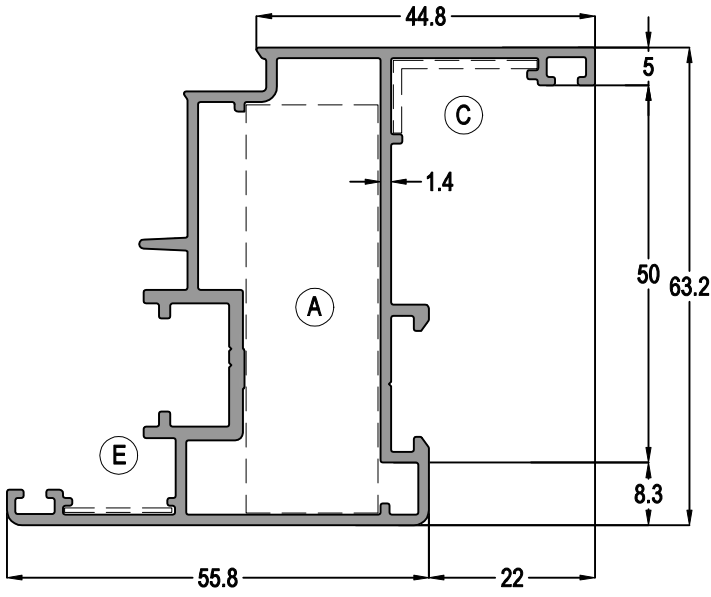
C55 117			Jx cm ⁴	Jy cm ⁴
			23,13	17,38
			AĞIRLIK / Weight	
ASI-KT 1455	ASI-MO 21	ASI-SB 19.1	1,169 kg/mt	



C55 115			Jx cm ⁴	Jy cm ⁴
			51,94	23,91
			AĞIRLIK / Weight	
ASI-KT 5542	ASI-MO 21	ASI-SB 19.1	1,351 kg/mt	

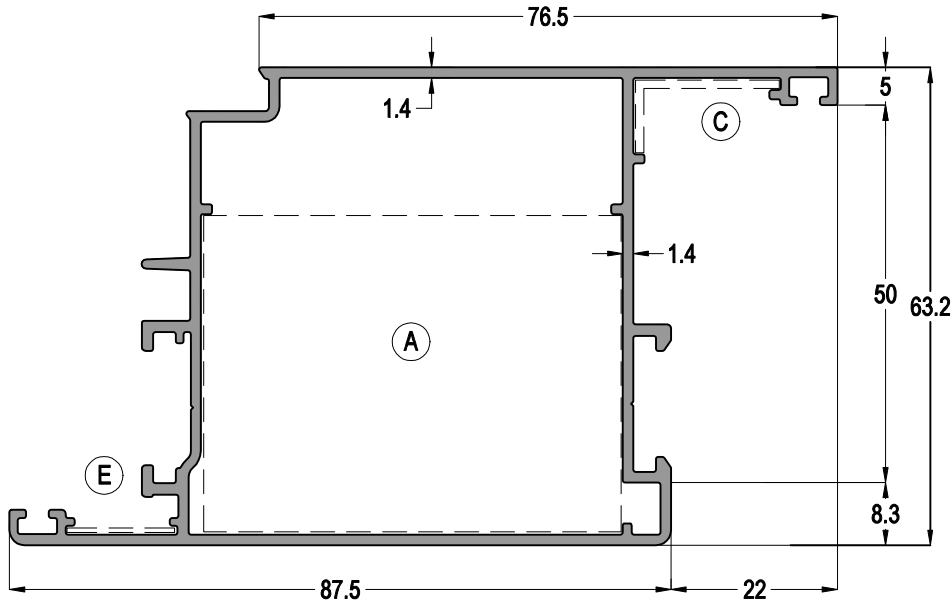

Profil ağırlıklarımız teorik olup; teslim anındaki tartımız geçerlidir.
Profile weights are theoretical and the weight at the time of delivery is valid.

C55 - 1,8mm

YALITIMSIZ KAPI-PENCERE SİSTEMİ
COLD WINDOW&DOOR SYSTEM



C55 51	Jx cm ⁴	Jy cm ⁴
	10,80	14,75
	AĞIRLIK / Weight	
		0,843 kg/mt

C55 52	Jx cm ⁴	Jy cm ⁴
	3,40	8,07
	AĞIRLIK / Weight	
		0,758 kg/mt

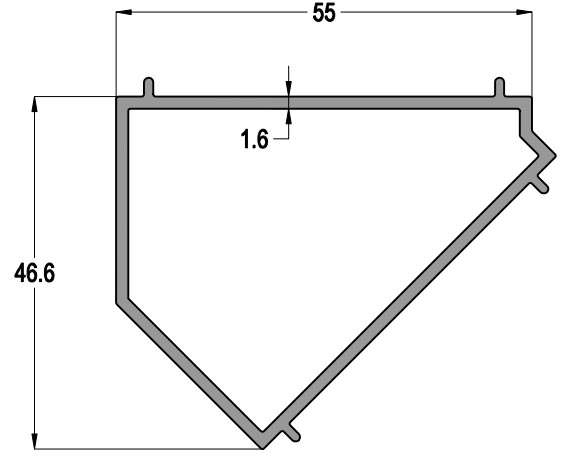
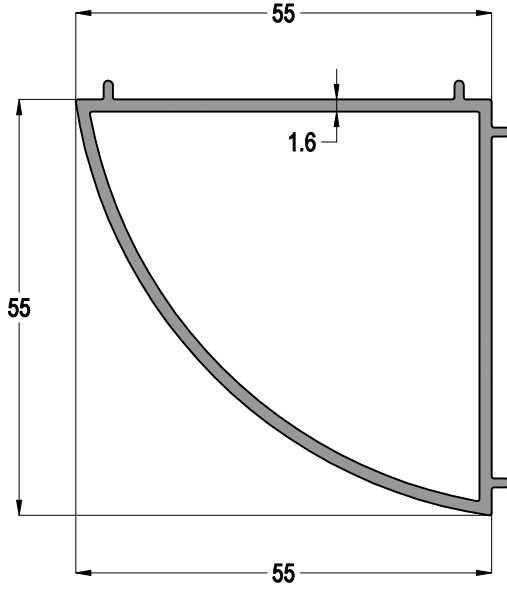

C55 54	
AĞIRLIK / Weight	
0,441 kg/mt	

01-000500-15	
AĞIRLIK / Weight	
0,619 kg/mt	

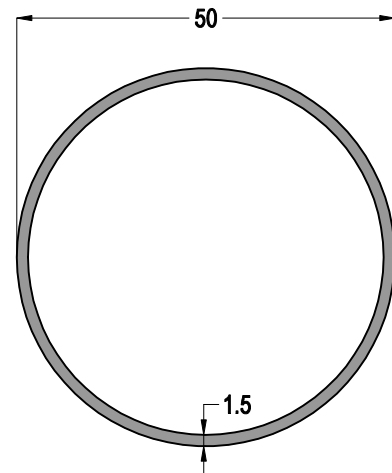
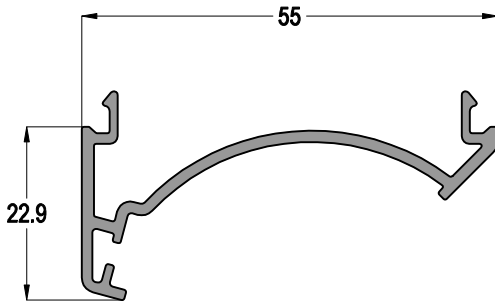

Profil ağırlıklarımız teorik olup; teslim anındaki tartımız geçerlidir.
Profile weights are theoretical and the weight at the time of delivery is valid.

C55 - 1,8mm

YALITIMSIZ KAPI-PENCERE SİSTEMİ
COLD WINDOW&DOOR SYSTEM

ASISTAL

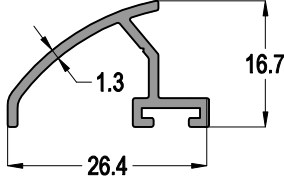

12-01

0,198 kg/mt

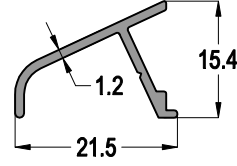

12-02

0,136 kg/mt

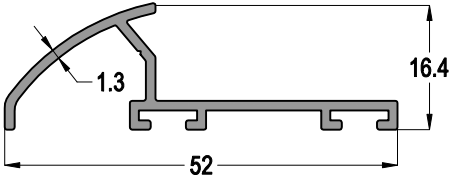

12-03

0,313 kg/mt

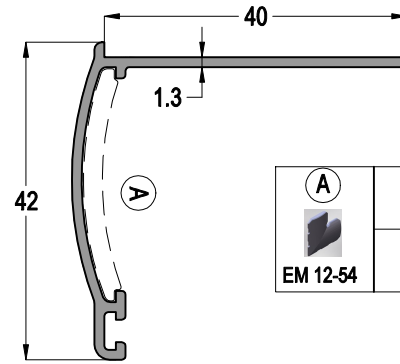

12-54

0,326 kg/mt

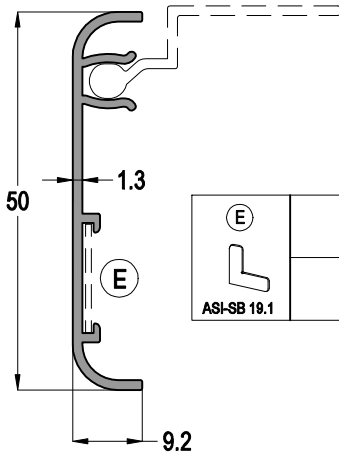

12-52

0,279 kg/mt

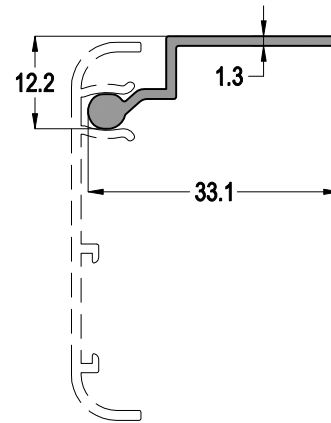

12-53

0,177 kg/mt

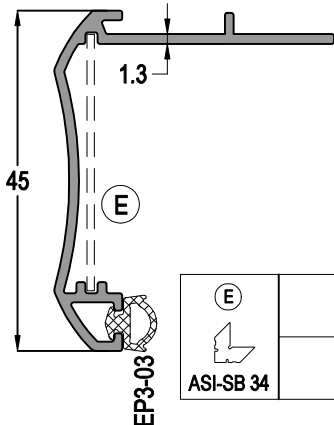

12-57

0,358 kg/mt

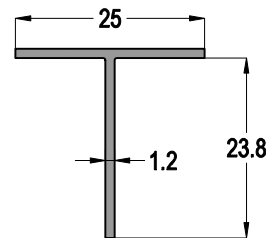

04-025025-12

0,158 kg/mt

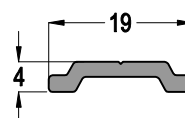

12-41

0,118 kg/mt

Profil ağırlıklarımız teorik olup; teslim anındaki tartımız geçerlidir.
Profile weights are theoretical and the weight at the time of delivery is valid.

C55 - 1,8mm

YALITIMSIZ KAPI-PENCERE SİSTEMİ
COLD WINDOW&DOOR SYSTEM

ASISTAL

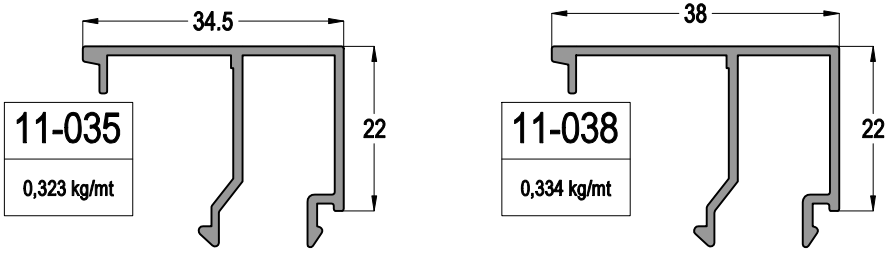
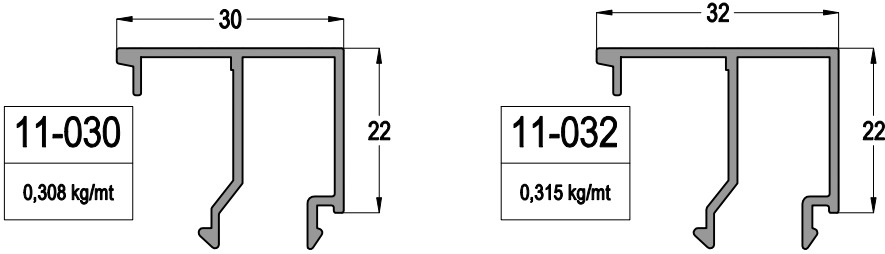
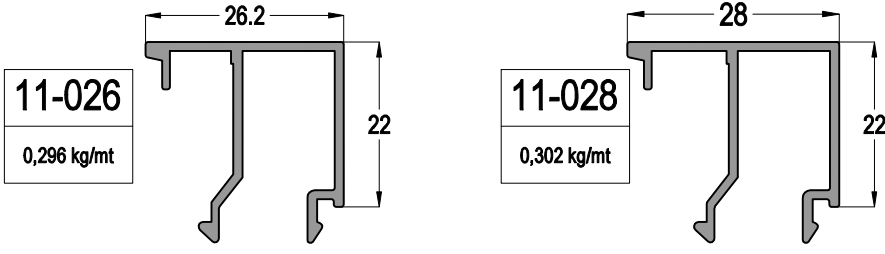
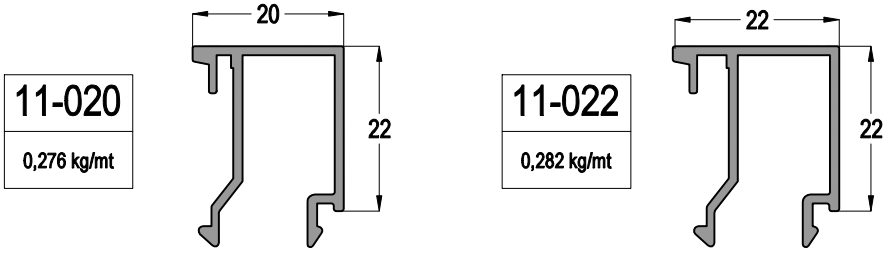
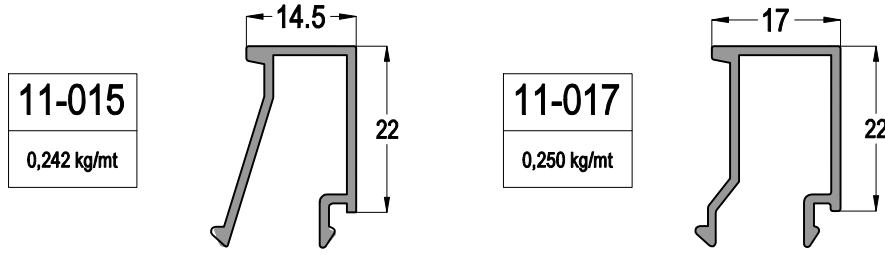
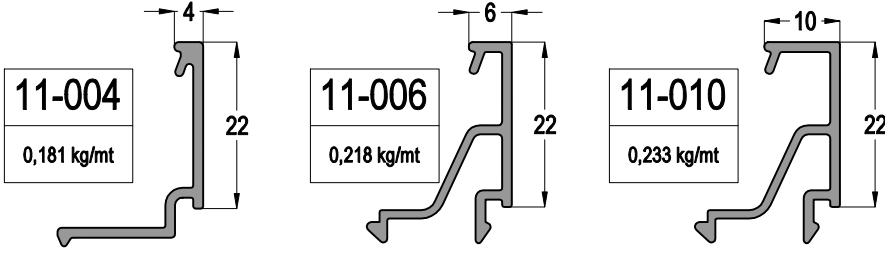

CAM KALINLIĞINA GÖRE CAM ÇİTASI SEÇİM TABLOSU
Glazing Bead Selection Table according to the Glass Thickness

CAM KALINLIĞI Glass Thickness (mm)	CAM ÇİTASI Glazing Bead	İÇ CAM FİTİLİ Glass Gasket (IN)	DIŞ CAM FİTİLİ Glass Gasket (OUT)
4	11-038	EP2-02	EP1-01
5	11-038	EP2-01	EP1-01
6	11-038	KC-02	EP1-01
7	11-035	EP2-02	EP1-01
8	11-035	EP2-01	EP1-01
9	11-035	KC-02	EP1-01
10	11-032	EP2-02	EP1-01
11	11-032	EP2-01	EP1-01
12	11-032	KC-02	EP1-01
13	11-030	EP2-01	EP1-01
14	11-030	KC-02	EP1-01
15	11-028	EP2-01	EP1-01
16	11-028	KC-02	EP1-01
17	11-026	EP2-01	EP1-01
18	11-026	KC-02	EP1-01
20	11-022	EP2-02	EP1-01
21	11-022	EP2-01	EP1-01
22	11-022	KC-02	EP1-01
23	11-020	EP2-01	EP1-01
24	11-020	KC-02	EP1-01
26	11-017	EP2-01	EP1-01
27	11-017	KC-02	EP1-01
28	11-015	EP2-01	EP1-01
29	11-015	KC-02	EP1-01
32	11-010	EP2-02	EP1-01
33	11-010	EP2-01	EP1-01
34	11-010	KC-02	EP1-01
36	11-006	EP2-02	EP1-01
37	11-006	EP2-01	EP1-01
38	11-006	KC-02	EP1-01
39	11-004	EP2-01	EP1-01
40	11-004	KC-02	EP1-01

Profil ağırlıklarımız teorik olup; teslim anındaki tartımız geçerlidir.

Profile weights are theoretical and the weight at the time of delivery is valid.

C55 - 1,8mm

YALITIMSIZ KAPI-PENCERE SİSTEMİ
COLD WINDOW&DOOR SYSTEM

ASISTAL

SİSTEM DETAYLARI
SYSTEM DETAILS

PENCERE AÇILIM DETAYLARI
WINDOW OPENING DETAILS

1

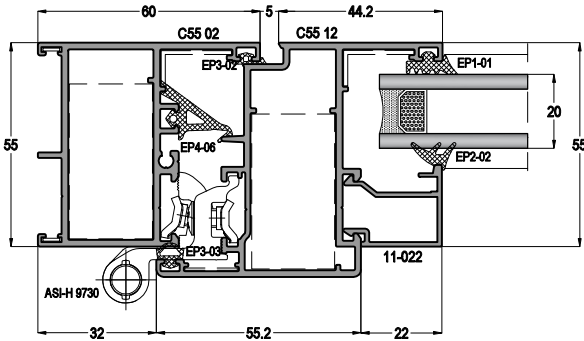

2

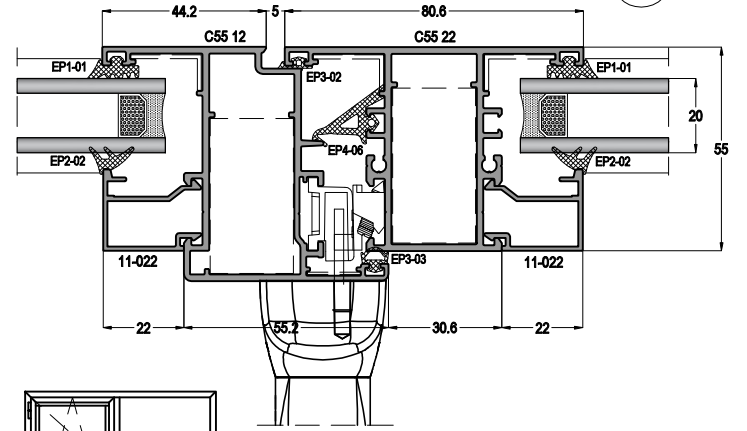

1a

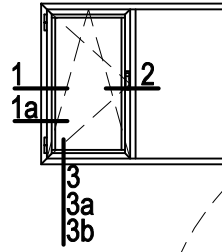
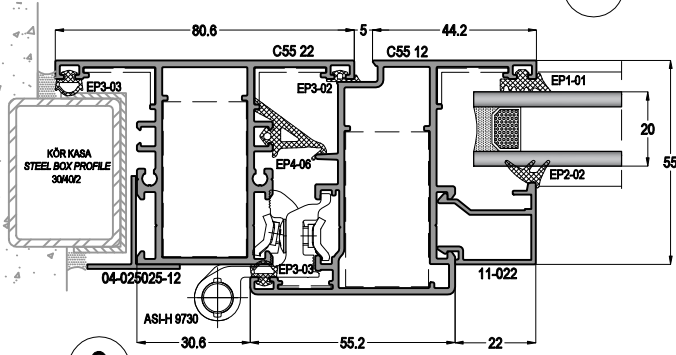

3a

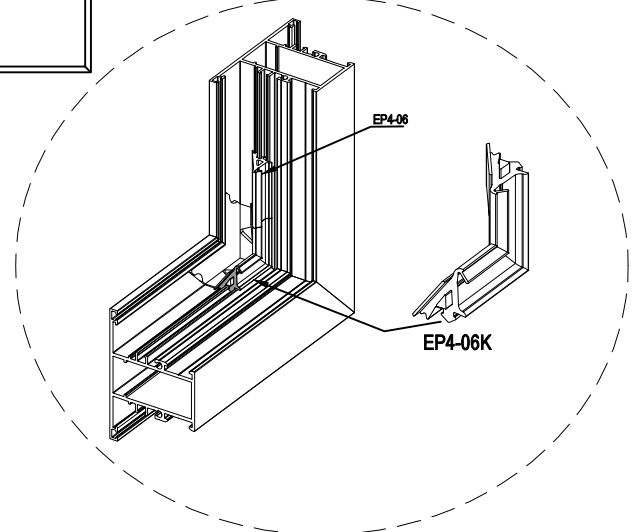

3

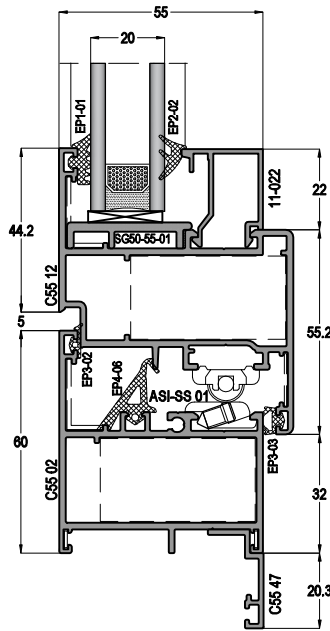
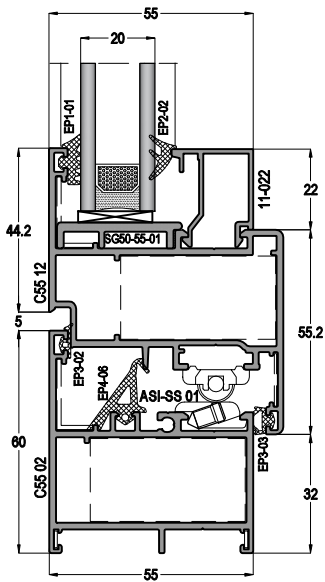

3b

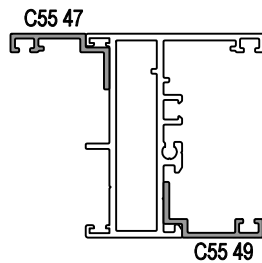
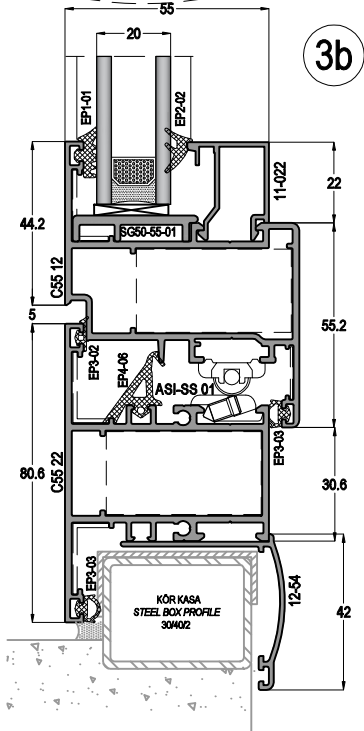

PENCERE AÇILIM DETAYLARI
WINDOW OPENING DETAILS

4

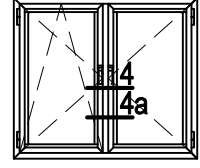
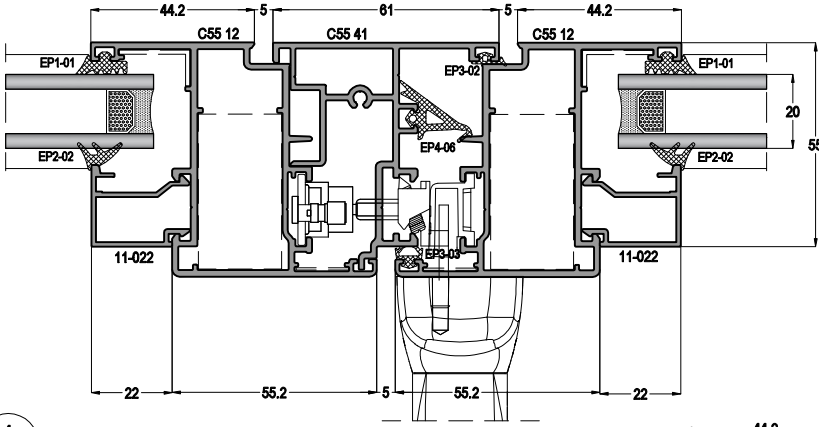

4a

1

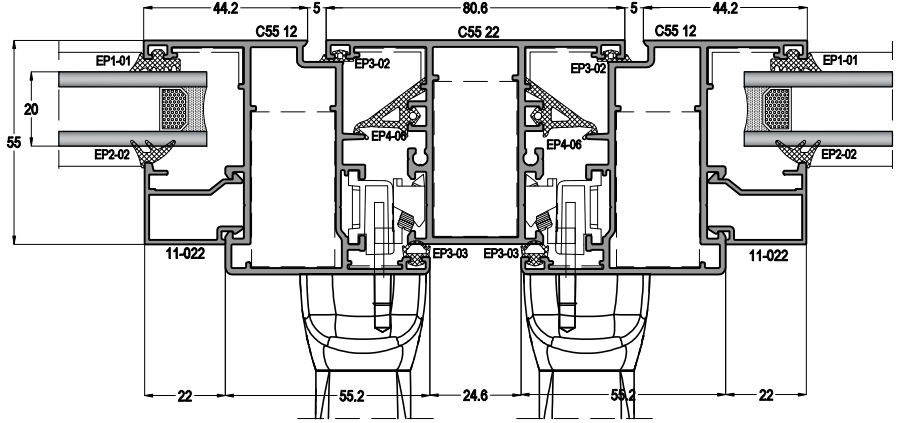
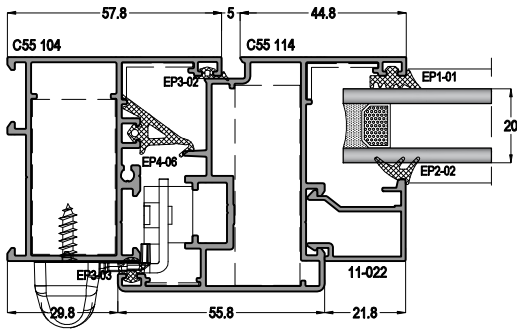

5

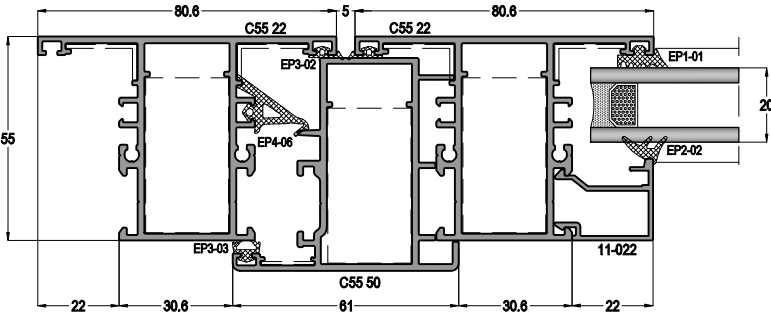
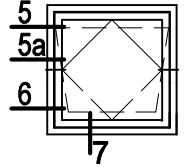
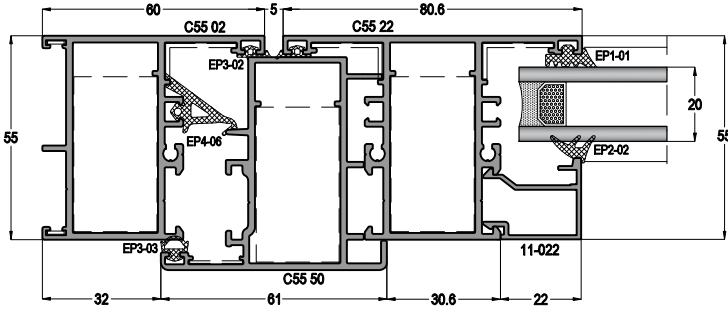

5a

7

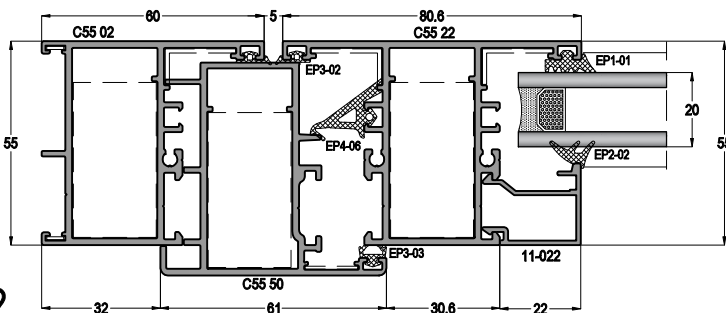

6

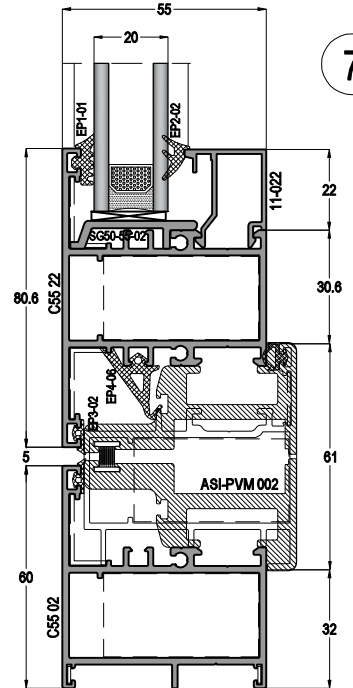

ö: 1/2

Profil ağırlıklarımız teorik olup; teslim anındaki tartımız geçerlidir.
Profile weights are theoretical and the weight at the time of delivery is valid.

İÇE AÇILIR KAPI DETAYLARI
INNER OPENING DOOR DETAILS

1

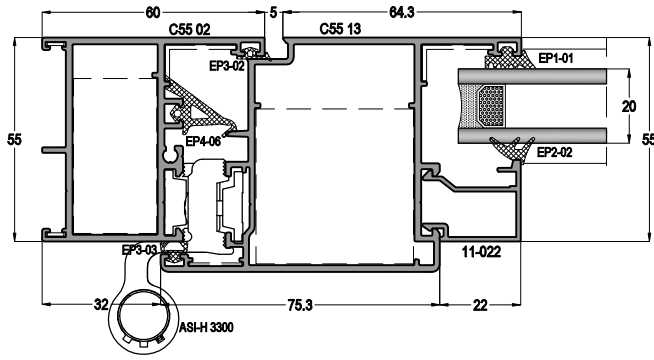

2

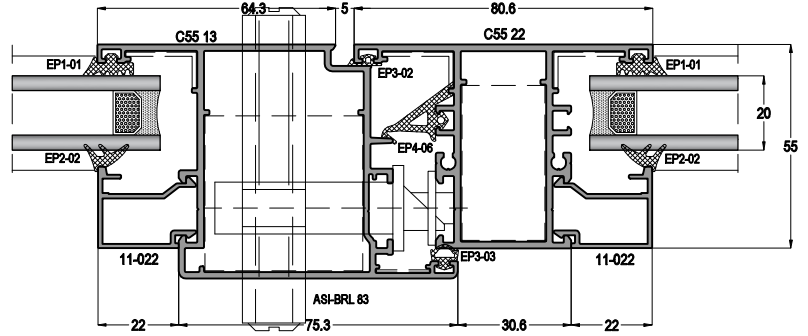

3

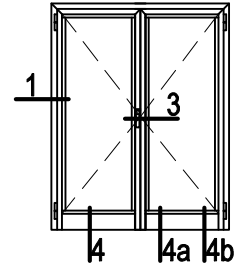
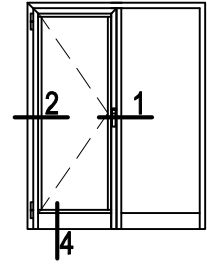
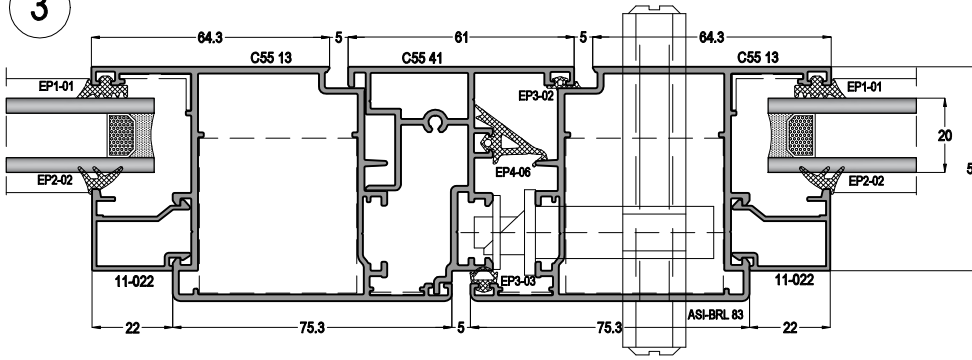

4

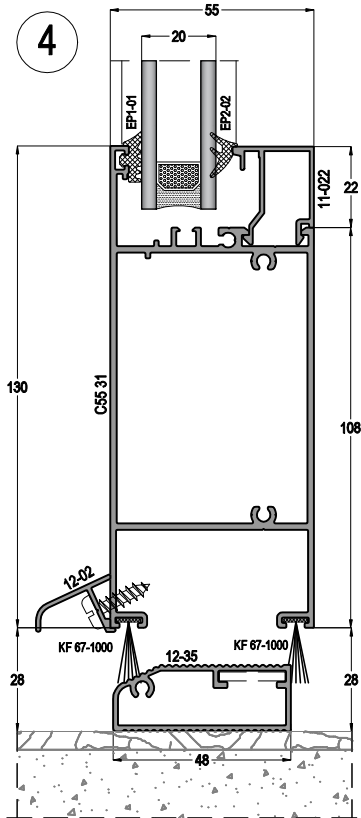

4a

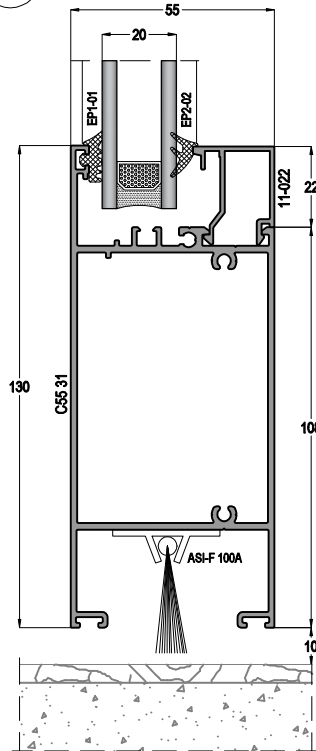

4b

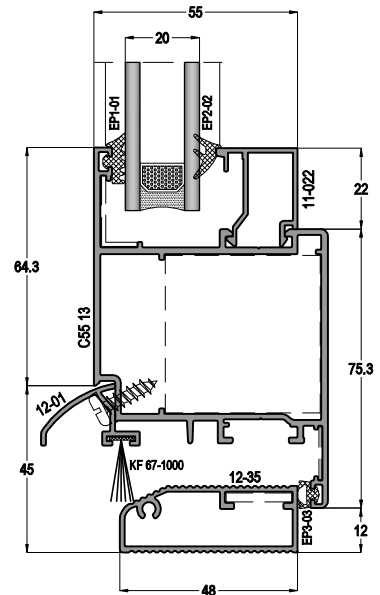

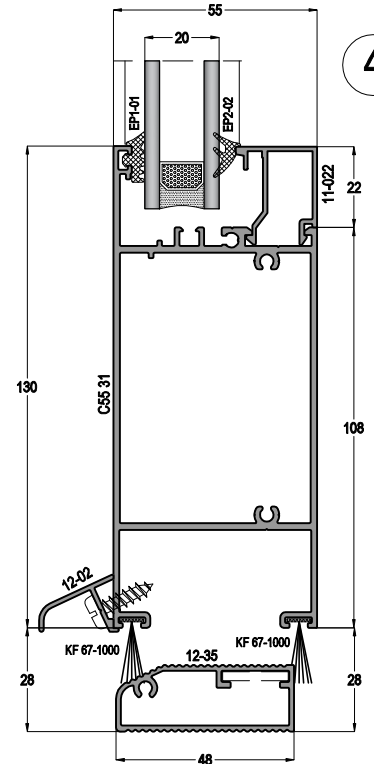
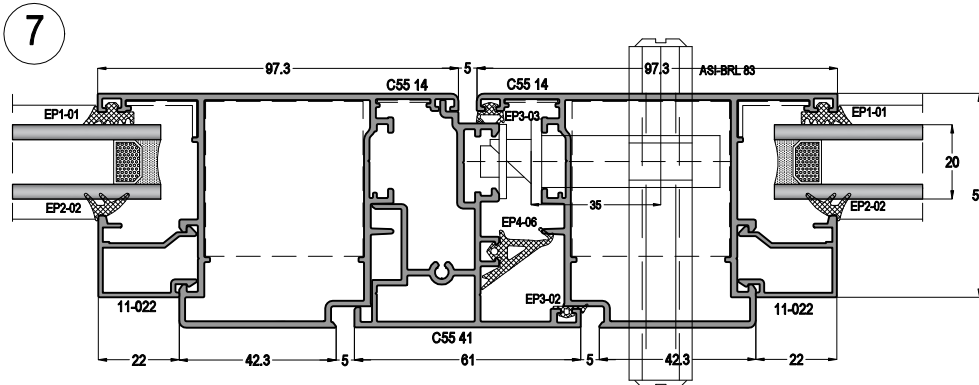
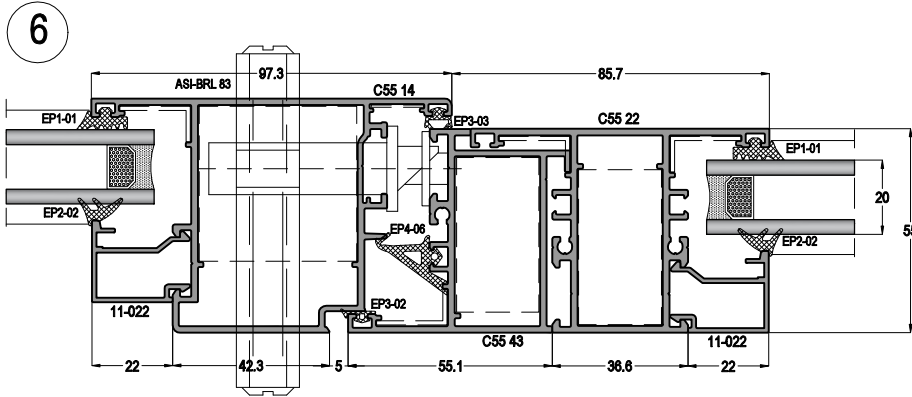
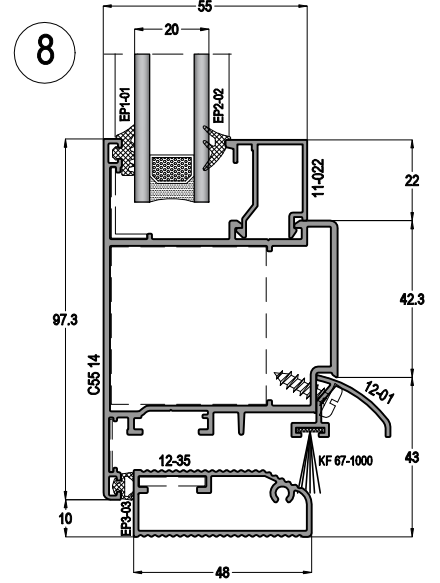
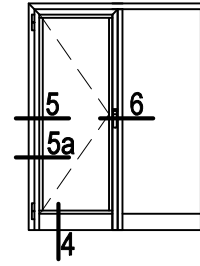
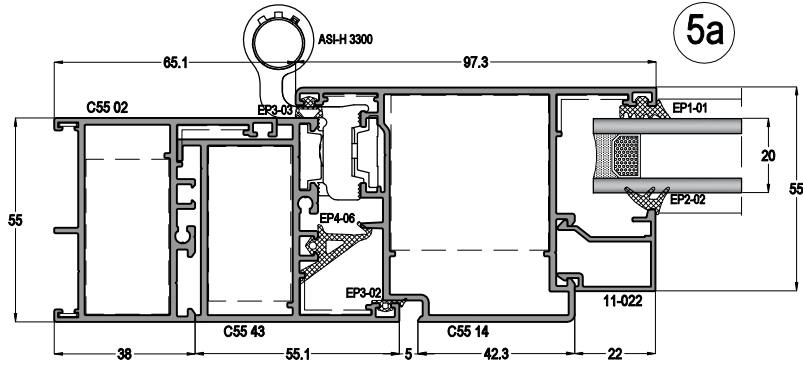
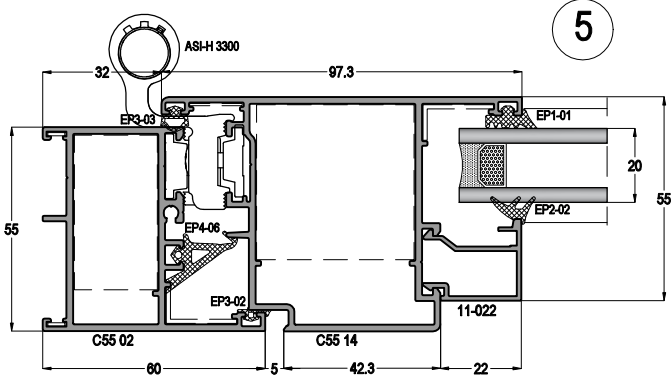
DIŞA AÇILIR KAPI DETAYLARI
OUTER OPENING DOOR DETAILS

C55

YALITIMSIZ KAPI-PENCERE SİSTEMİ
COLD WINDOW&DOOR SYSTEM

ASİSTAL

ÇARPMA KAPI DETAYLARI SWING DOOR DETAILS

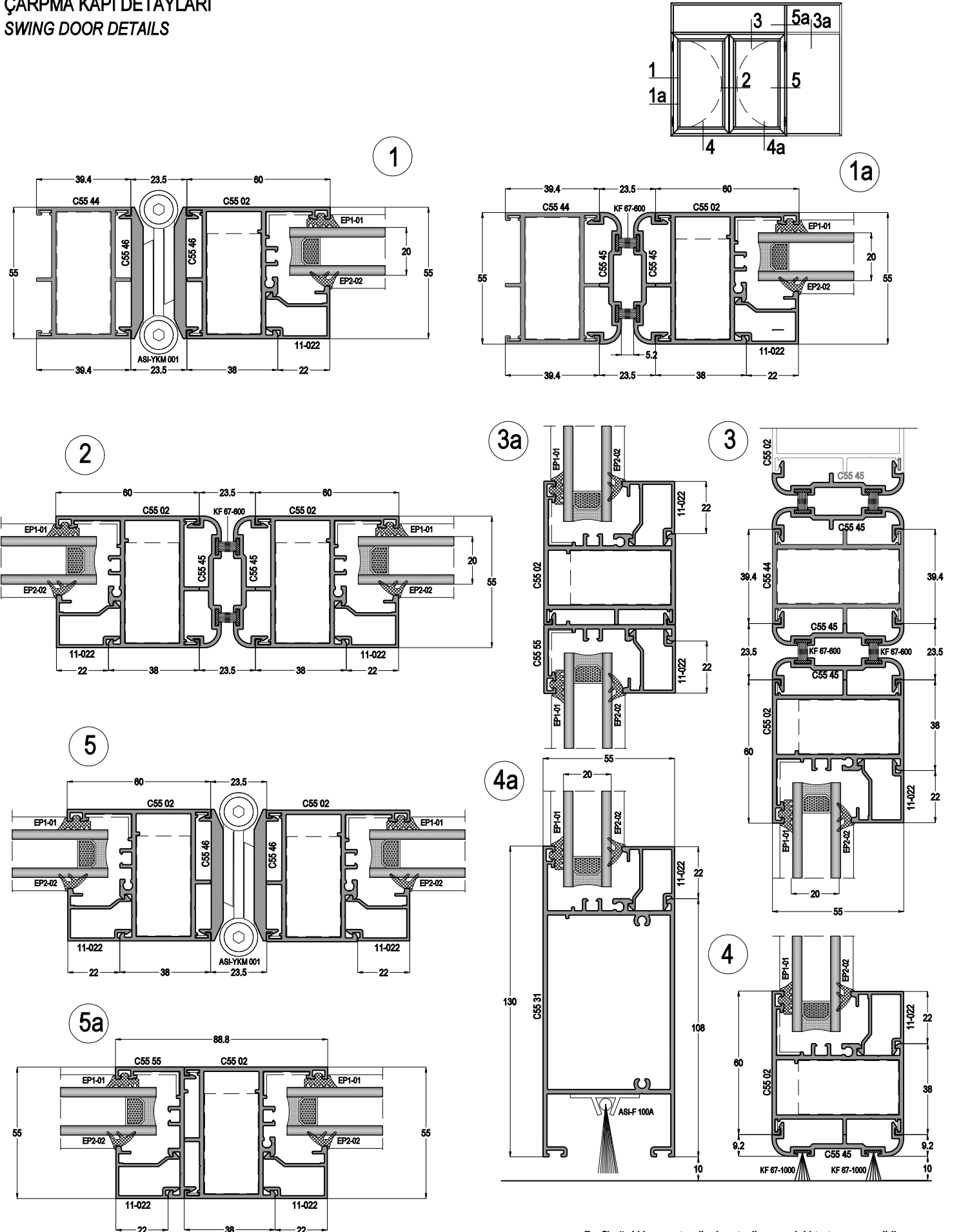

Ö: 1/2

Profil ağırlıklarımız teorik olup; teslim anındaki tartımız geçerlidir.
Profile weights are theoretical and the weight at the time of delivery is valid.

C55

YALITIMSIZ KAPI-PENCERE SİSTEMİ
COLD WINDOW&DOOR SYSTEM

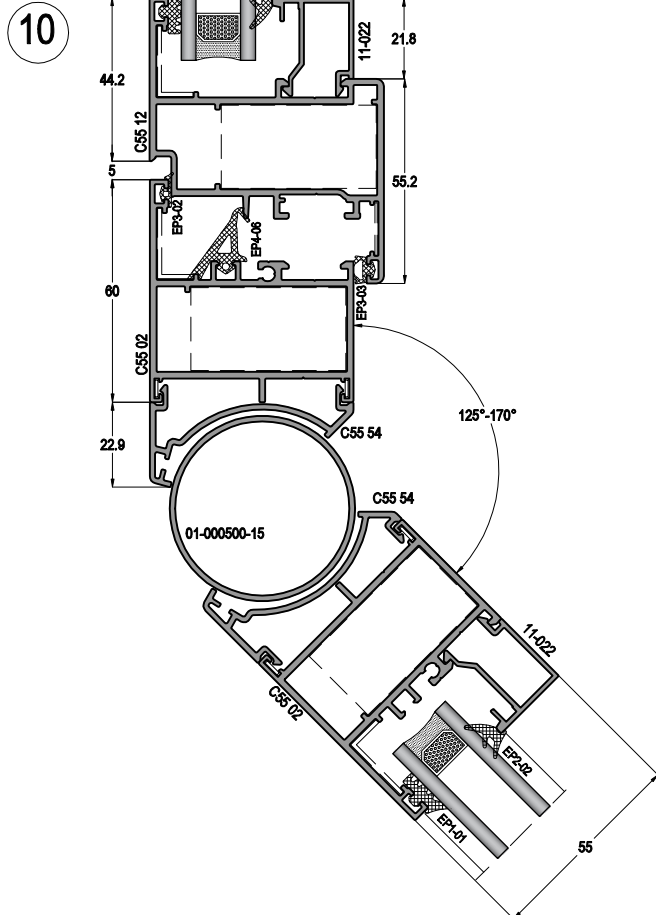
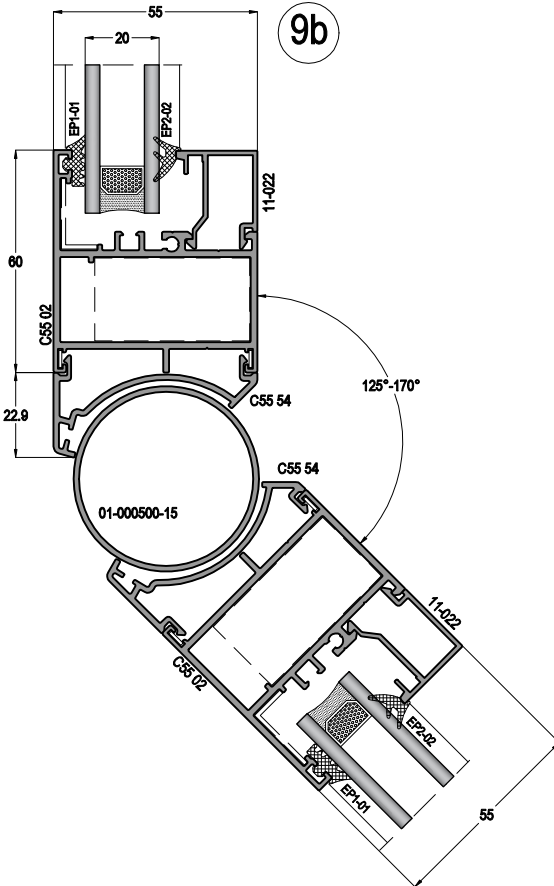
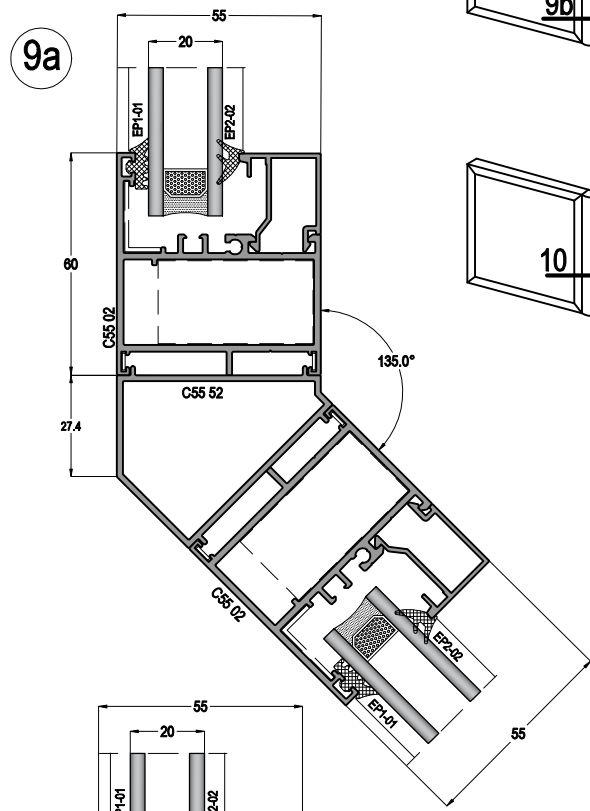
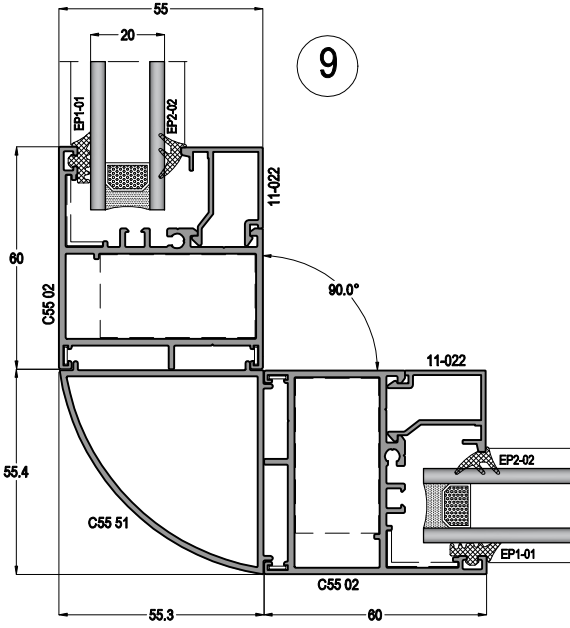
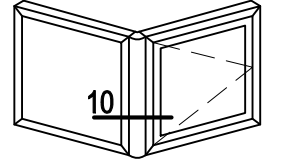
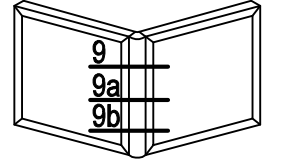

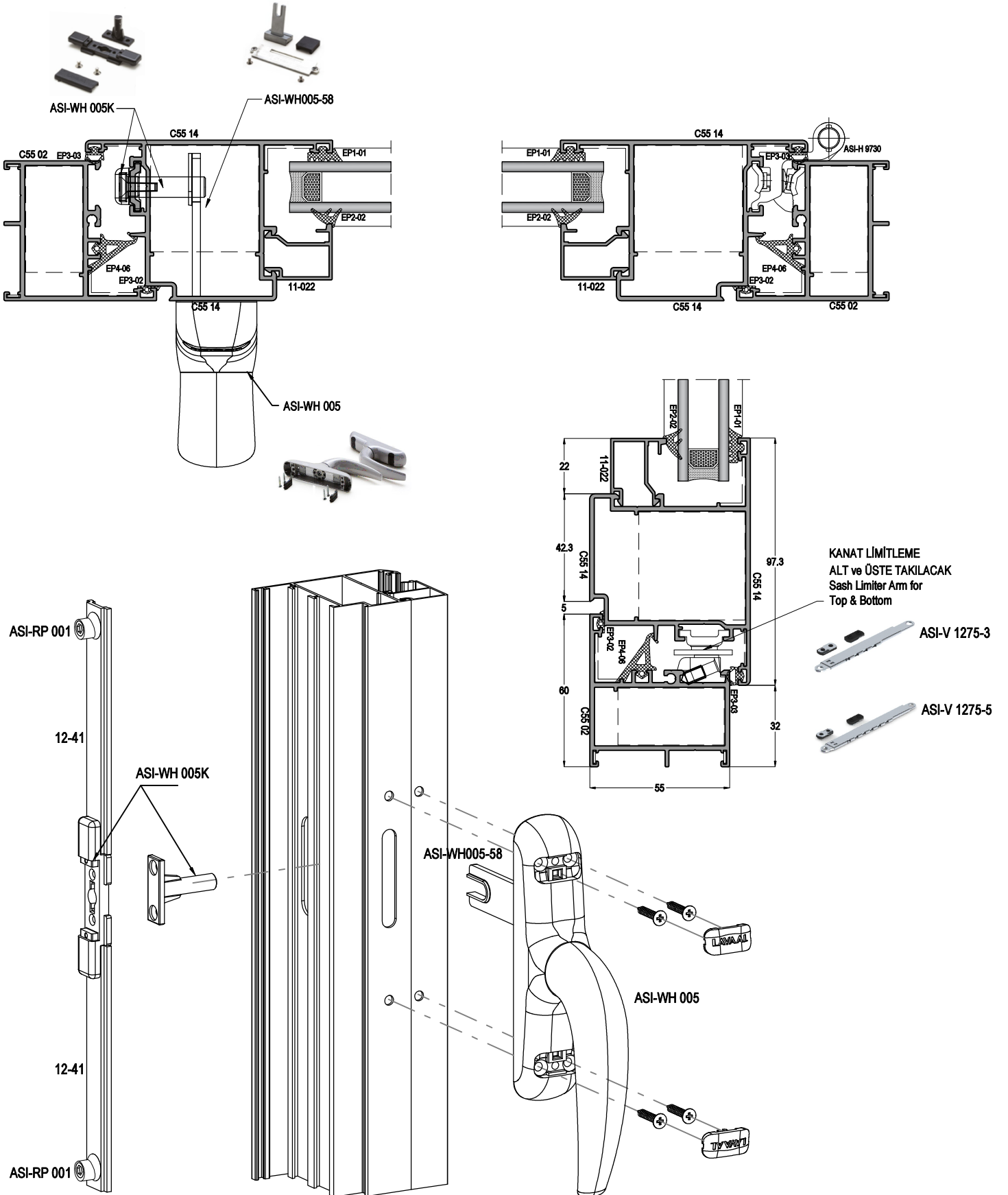
DIŞA AÇILIR PENCERE DETAYI
OUTER OPENING WINDOW DETAILS

DIŞA AÇILIR PENCERE DETAYI
OUTER OPENING WINDOW DETAILS
THS62 17

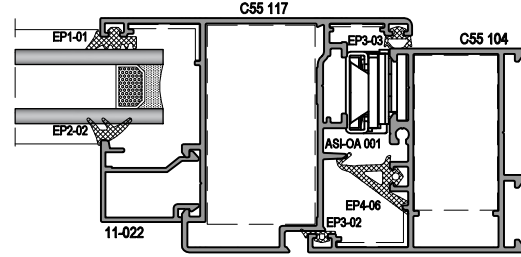
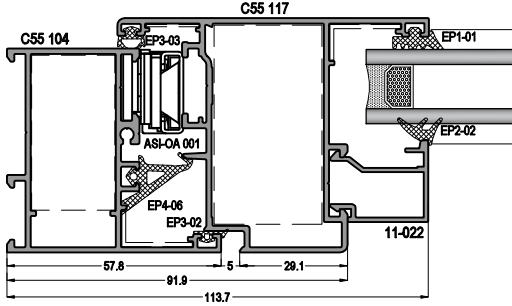

DIŞA AÇILIM PENCERE
OUT SIDE HUNG

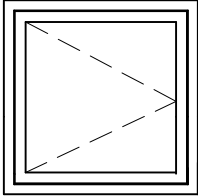

DIŞA VASİSTAS
OUT TOP HUNG

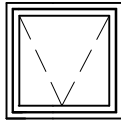
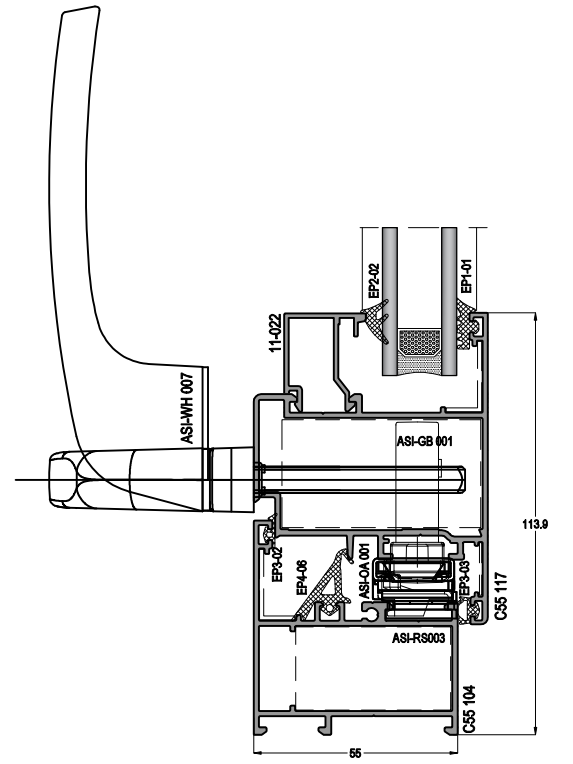
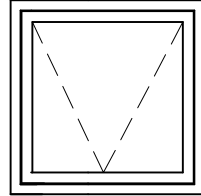

DIŞA AÇILIM VASİSTAS MAKAS SEÇİMİ
Top-Hung Arm Selections

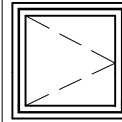

DIŞA AÇILIM PENCERE MAKAS SEÇİMİ
Side-Hung Arm Selections

AÇIKLAMA Description	KOD Item Code	Max. Açılır Açısı Max. Opening Angle	Max. Yükseklik Max. Height (mm)	Max. Genişlik Max. Width (mm)	Max. Ağırlık Max. Weight (Kg)	Makas Yüksekliği Arm Length (mm)	Max. Açılır Açısı Max. Opening Angle	Max. Yükseklik Max. Height (mm)	Max. Genişlik Max. Width (mm)	Max. Ağırlık Max. Weight (Kg)
DIŞA AÇILIM MAKAS-10" Eurogrove Arm	ASI-OA 001	50°	650	1500	50	259	50° 84° *	1500	650	35
DIŞA AÇILIM MAKAS-16" Eurogrove Arm	ASI-OA 002	30° 50°	800	1500	100 55	412	30° - 50° 90° *	1600	700	60 42
DIŞA AÇILIM MAKAS-22" Eurogrove Arm	ASI-OA 003	20° 45°	1500	1700	100 80	567	-	-	-	-
DIŞA AÇILIM MAKAS-28" Eurogrove Arm	ASI-OA 004	15°	2000	1700	100	711	-	-	-	-

Profil ağırlıklarımız teorik olup; teslim anındaki tartımız geçerlidir.
Profile weights are theoretical and the weight at the time of delivery is valid.

C55

YALITIMSIZ KAPI-PENCERE SİSTEMİ
COLD WINDOW&DOOR SYSTEM

ASISTAL

KESİM ve MONTAJ
CUTTING & ASSEMBLY

C55

YALITIMSIZ KAPI-PENCERE SİSTEMİ
COLD WINDOW&DOOR SYSTEM

ASISTAL

KÖŞE VULKANİZE FİTİL MONTAJI

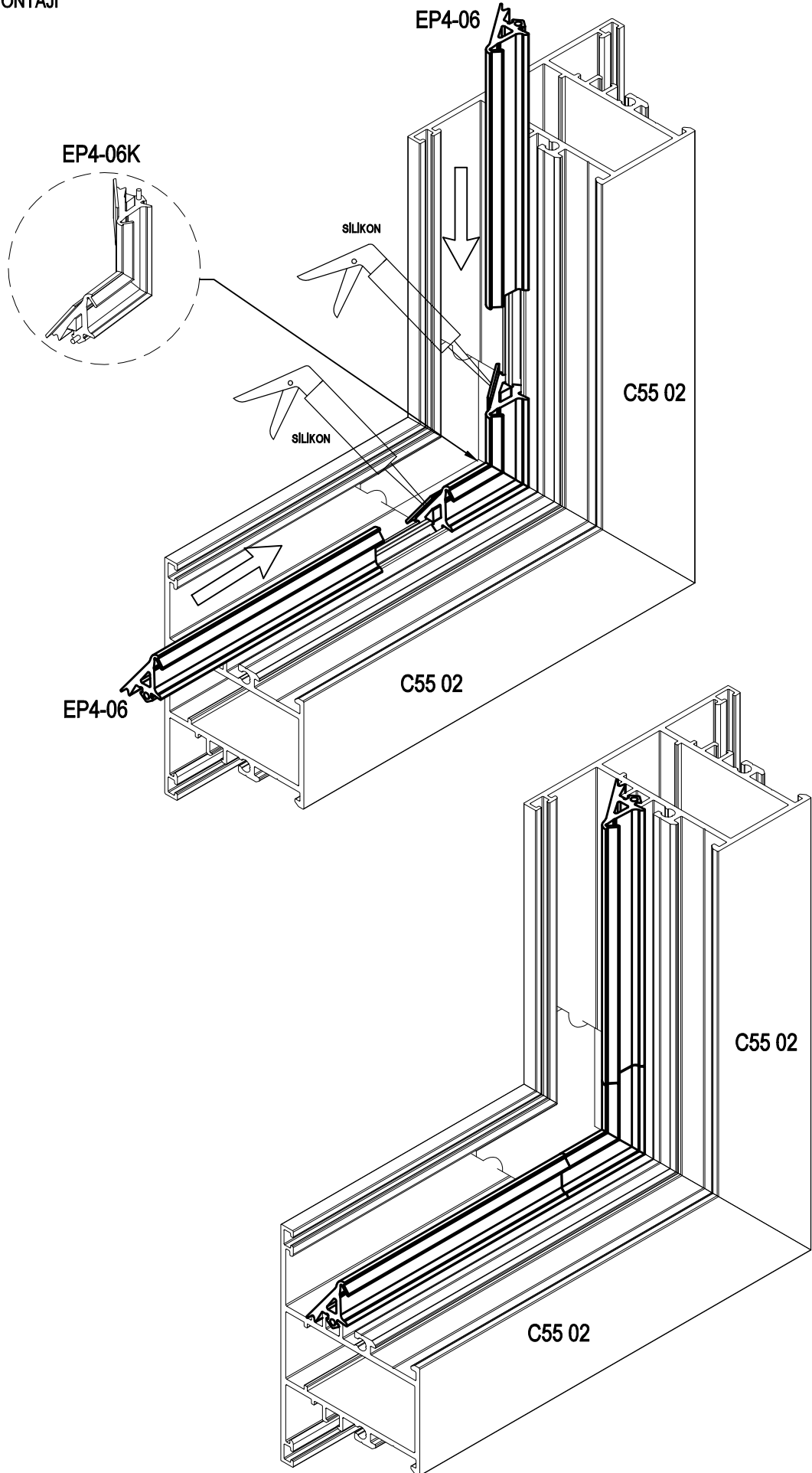

LAVAAL ÇİFT EKSEN AÇILIM AKSESUAR KULLANIM TABLOSU
ALU - ALU TT

LAVAAL TILT&TURN OPENING ACCESSORIES TABLE

STANDART KİT / ASI-LTT-S01

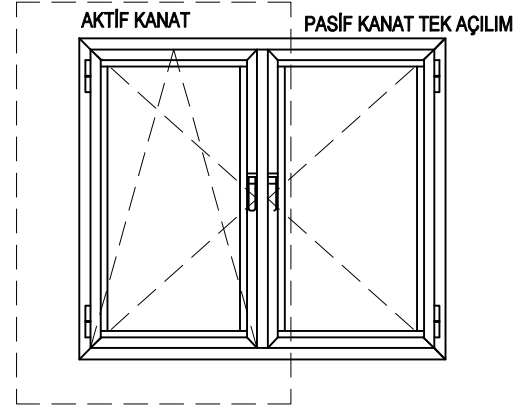
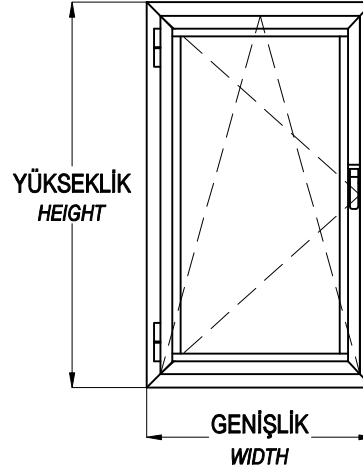
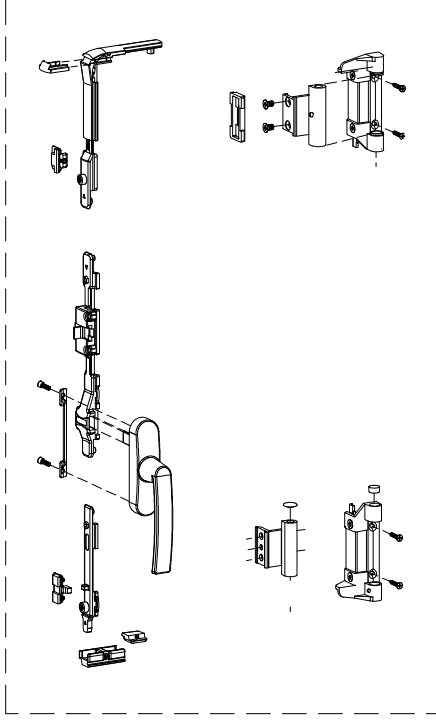

	ASI-LTT-S01	ASI-LTT-M01	ASI-LTT-M02	ASI-LTT-M03	ASI-LTT-M04	ASI-LTT-B01
KANAT GENİŞLİK / Sash Widht : 345-400mm	X	X				
KANAT GENİŞLİK / Sash Widht : 401-540mm	X		X			
KANAT GENİŞLİK / Sash Widht : 541-1100mm	X			X		
KANAT GENİŞLİK / Sash Widht : 1100-1500mm	X			X	X	
KANAT YÜKSEKLİK / Sash Height : < 1400mm						X

C55

YALITIMSIZ KAPI-PENCERE SİSTEMİ
COLD WINDOW&DOOR SYSTEM

ASISTAL

LAVAAL ÇİFT EKSEN AÇILIM ÇİFT KANAT AKSESUAR KULLANIM TABLOSU ALU - ALU TT

LAVAAL TILT&TURN OPENING ACCESSORIES TABLE

STANDART KİT / ASI-LTT-S01

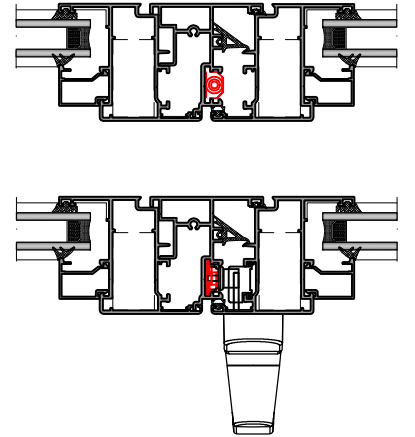
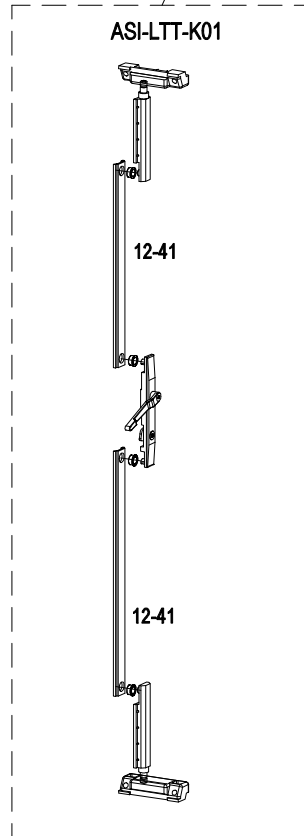
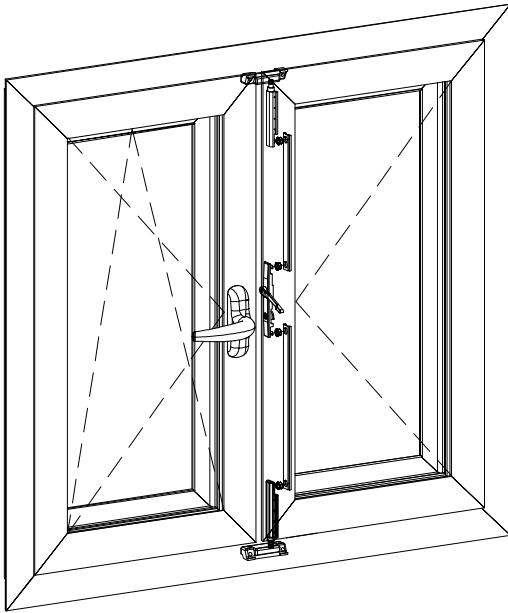
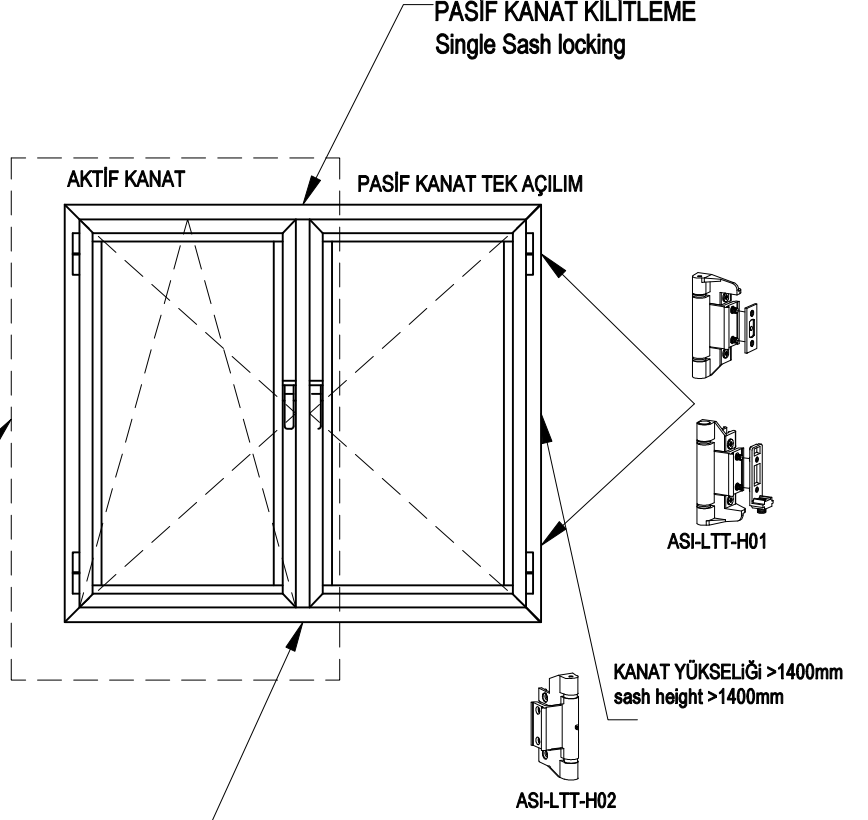
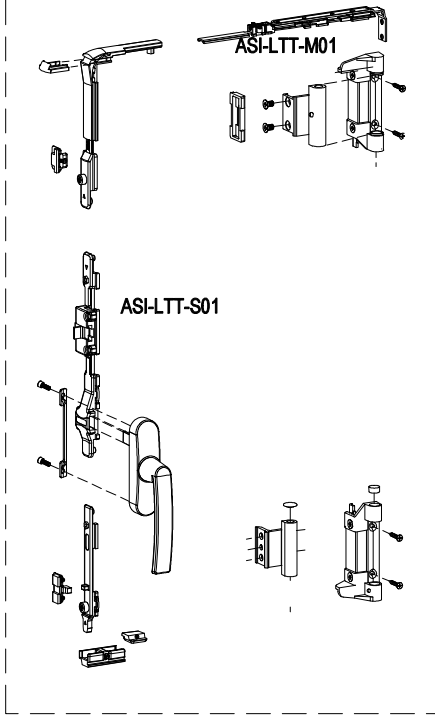

MULTI POINT SİSTEM (PVC KANALLI) ÇİFT EKSEN AÇILIM AKSESUAR TABLOSU
MULTI POINT SYSTEM TILT&TURN OPENING ACCESSORIES TABLE

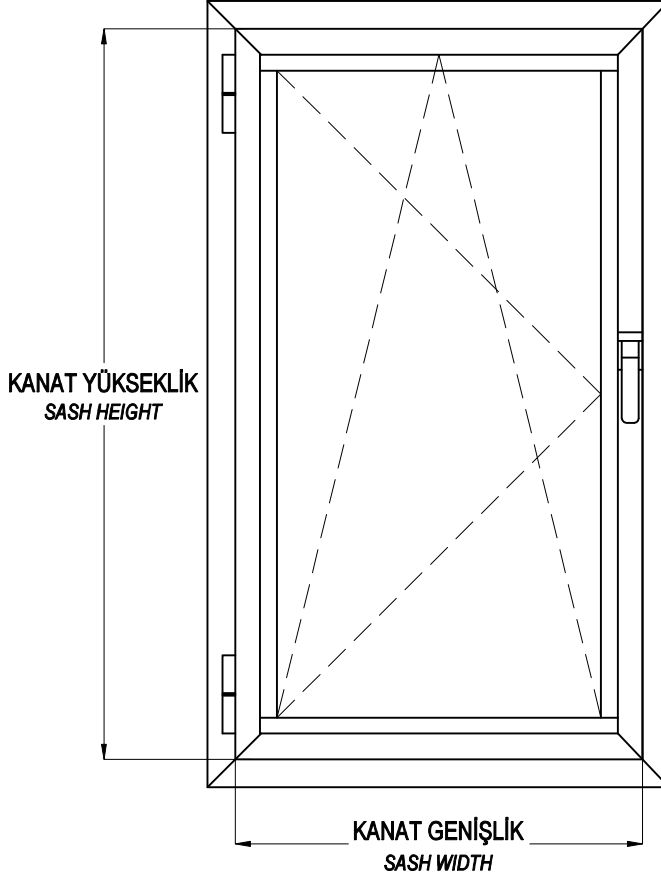

MULTI POINT (PVC KANALLI) KİLİTLEME AKSESUAR SEÇİM TABLOSU
MULTI POINT SYSTEM ACCESSORIES TABLE

YÜKSEKLİK - HEIGHT	GENİŞLİK - WIDTH				
	400-650mm	600-850mm	850-1100mm	1100-1350mm	1350mm-1600mm
450-700 mm	ASI-PVC TT 01	ASI-PVC TT 02	ASI-PVC TT 03	ASI-PVC TT 04	
700-1200 mm	ASI-PVC TT 05	ASI-PVC TT 06	ASI-PVC TT 07	ASI-PVC TT 08	ASI-PVC TT 09
1200-1400 mm	ASI-PVC TT 10	ASI-PVC TT 11	ASI-PVC TT 12	ASI-PVC TT 013	ASI-PVC TT 14
1400-1700 mm	ASI-PVC TT 15	ASI-PVC TT 16	ASI-PVC TT 017	ASI-PVC TT 18	ASI-PVC TT 19
1700-2400 mm	ASI-PVC TT 20	ASI-PVC TT 21	ASI-PVC TT 22	ASI-PVC TT 23	ASI-PVC TT 24

C 55

YALITIMLI KAPI-PENCERE SİSTEMİ
THERMAL WINDOW&DOOR SYSTEM



MULTI POINT SİSTEM (PVC KANALLI) TEK EKSEN AÇILIM AKSESUARLARI
MULTI POINT SYSTEM SINGLE OPENING ACCESSORIES

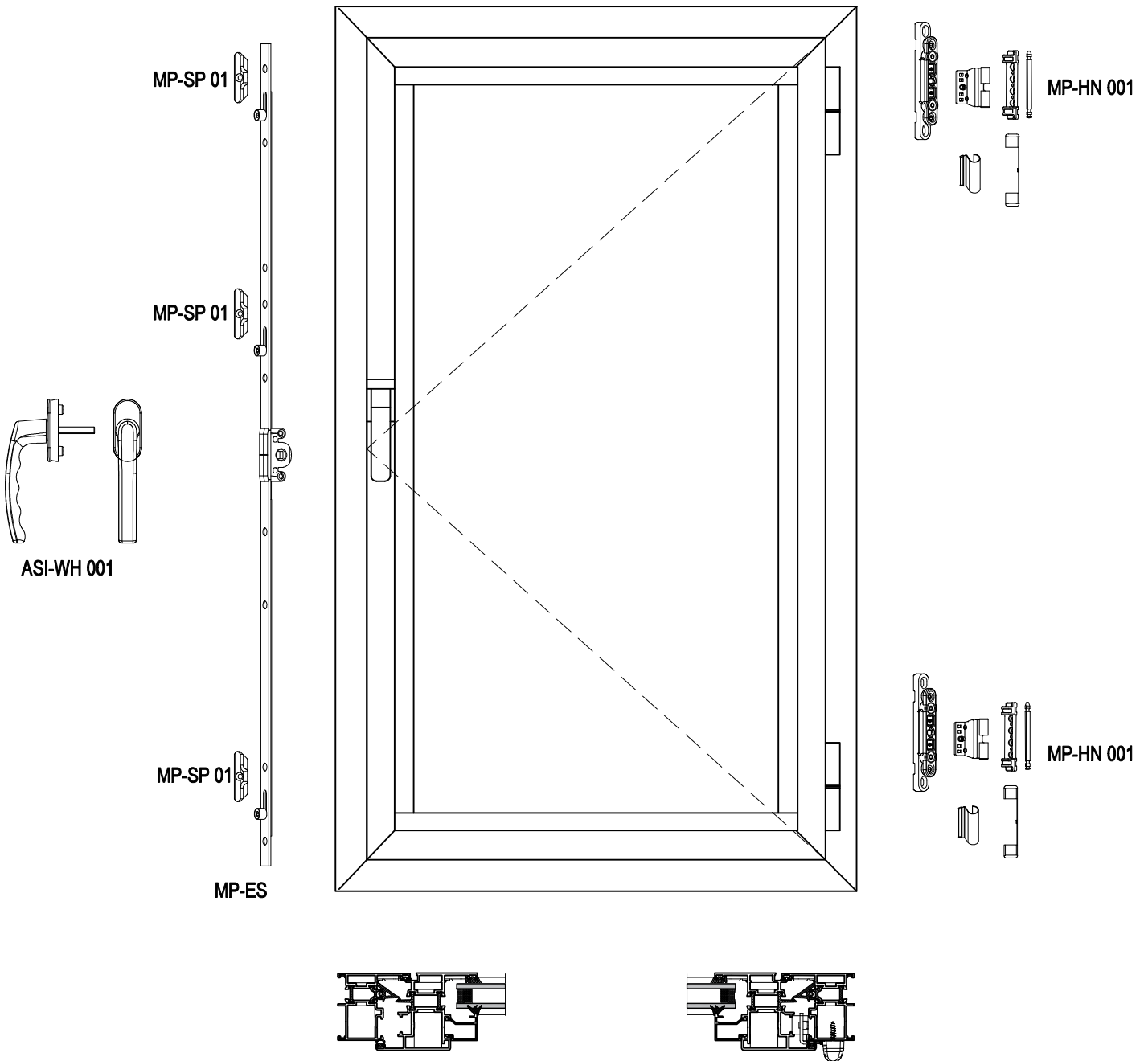

C55 - 1,8mm

YALITIMSIZ KAPI-PENCERE SİSTEMİ
COLD WINDOW&DOOR SYSTEM

ASISTAL

TEK KANAT AÇILIM KESİM ÖLÇÜLERİ SINGLE SASH CUTTING SIZES

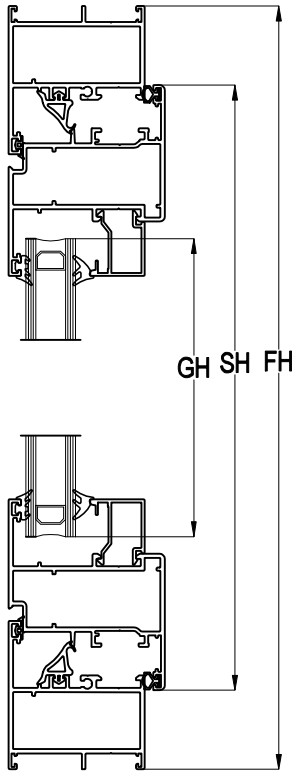
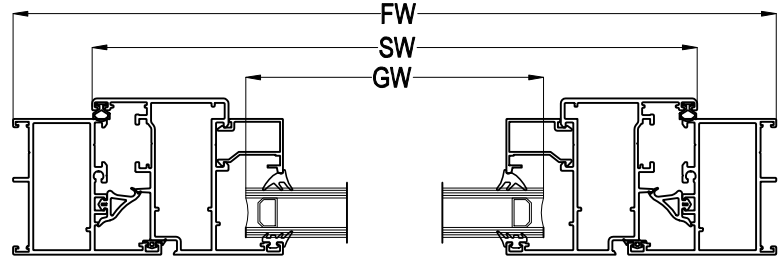
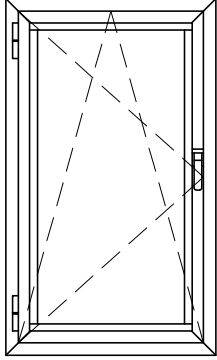

FW= KASA GENİŞLİĞİ / FRAME WIDTH
SW= KANAT GENİŞLİĞİ / SASH WIDTH
GW= CAM GENİŞLİĞİ / GLASS WIDTH

FH= KASA YÜKSEKLİĞİ / FRAME HEIGHT
SH= KANAT YÜKSEKLİĞİ / SASH HEIGHT
GH= CAM YÜKSEKLİĞİ / GLASS HEIGHT

KASA PROFİLİ FRAME PROFILE	KANAT PROFİLİ SASH PROFILE	KESİM ÖLÇÜLERİ CUTTING SIZES
C55 01	C55 11	SW = FW - 40mm GW = SW - 96,4mm SH = FH - 40mm GH = SH - 96,4mm
C55 01	C55 12	SW = FW - 40mm GW = SW - 120,4mm SH = FH - 40mm GH = SH - 120,4mm
C55 01	C55 13 C55 14	SW = FW - 40mm GW = SW - 160,4mm SH = FH - 40mm GH = SH - 160,4mm
C55 01	C55 15	SW = FW - 40mm GW = SW - 186mm SH = FH - 40mm GH = SH - 186mm
C55 02	C55 11	SW = FW - 64mm GW = SW - 96,4mm SH = FH - 64mm GH = SH - 96,4mm
C55 02	C55 12	SW = FW - 64mm GW = SW - 120,4mm SH = FH - 64mm GH = SH - 120,4mm
C55 02	C55 13 C55 14	SW = FW - 64mm GW = SW - 160,4mm SH = FH - 64mm GH = SH - 160,4mm
C55 02	C55 15	SW = FW - 64mm GW = SW - 186mm SH = FH - 64mm GH = SH - 186mm

C55 - 1,8mm

YALITIMSIZ KAPI-PENCERE SİSTEMİ
COLD WINDOW&DOOR SYSTEM

ASISTAL

ÇİFT KANAT AÇILIM KESİM ÖLÇÜLERİ DOUBLE SASH CUTTING SIZES

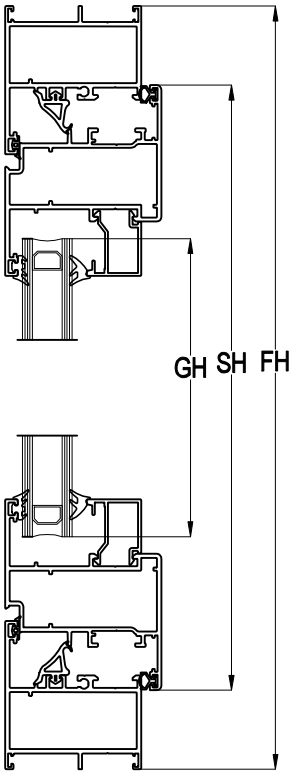
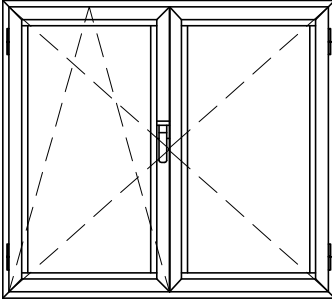
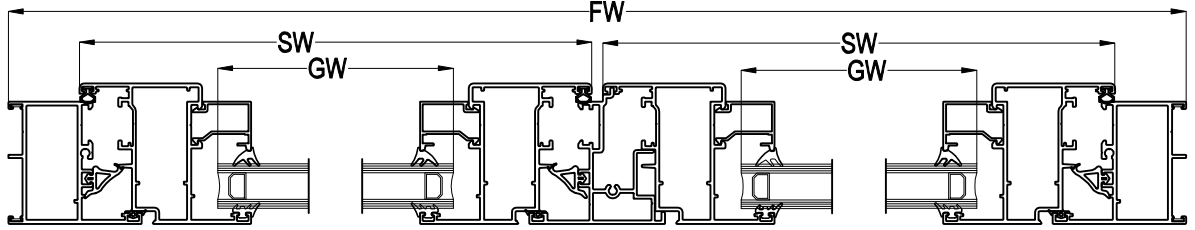

ADAPTÖR PROFİLİ
C55 41 = SH - 68,6mm

FW= KASA GENİŞLİĞİ / FRAME WIDTH

SW= KANAT GENİŞLİĞİ / SASH WIDTH

GW= CAM GENİŞLİĞİ / GLASS WIDTH

FH= KASA YÜKSEKLİĞİ / FRAME HEIGHT

SH= KANAT YÜKSEKLİĞİ / SASH HEIGHT

GH= CAM YÜKSEKLİĞİ / GLASS HEIGHT

KASA PROFİLİ FRAME PROFILE	KANAT PROFİLİ SASH PROFILE	KESİM ÖLÇÜLERİ CUTTING SIZES
C55 01	C55 11	SW = FW / 2 - 22,5mm GW = SW - 96,4mm SH = FH - 40mm GH = SH - 96,4mm
C55 01	C55 12	SW = FW / 2 - 22,5mm GW = SW - 120,4mm SH = FH - 40mm GH = SH - 120,4mm
C55 01	C55 13 C55 14	SW = FW / 2 - 22,5mm GW = SW - 160,4mm SH = FH - 40mm GH = SH - 160,4mm
C55 01	C55 15	SW = FW / 2 - 22,5mm GW = SW - 186mm SH = FH - 40mm GH = SH - 186mm
C55 02	C55 11	SW = FW / 2 - 34,5mm GW = SW - 96,4mm SH = FH - 64mm GH = SH - 96,4mm
C55 02	C55 12	SW = FW / 2 - 34,5mm GW = SW - 120,4mm SH = FH - 64mm GH = SH - 120,4mm
C55 02	C55 13 C55 14	SW = FW / 2 - 34,5mm GW = SW - 160,4mm SH = FH - 64mm GH = SH - 160,4mm
C55 02	C55 15	SW = FW / 2 - 34,5mm GW = SW - 186mm SH = FH - 64mm GH = SH - 186mm